

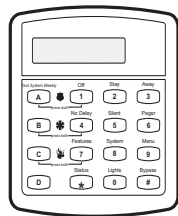

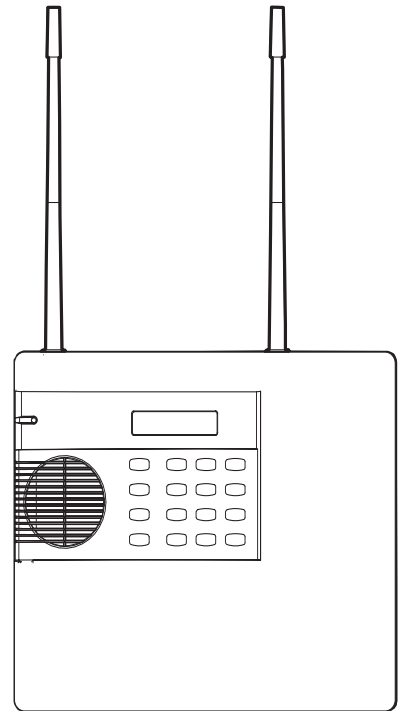

# INTERNATIONAL CONCORD™

## *User's Guide*

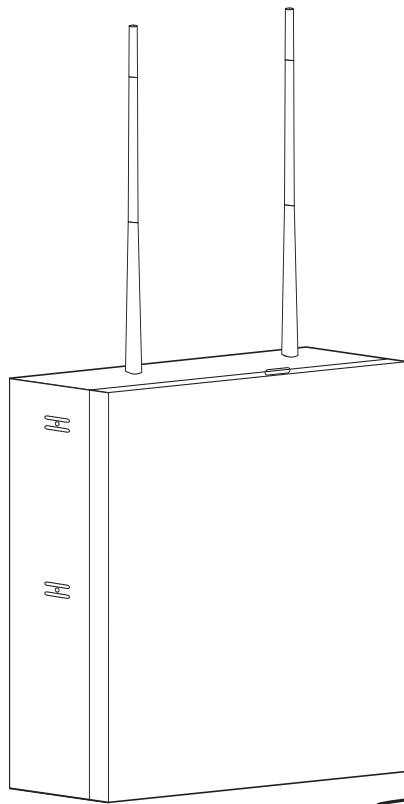

Document No. 466-1763-HS Rev. B

## Commands at a Glance

Disarm the system. Cancel an accidental alarm.	<b>1</b> + CODE
Arm to Level 2—HOME.	<b>2</b> + CODE
Arm to Level 3—AWAY.	<b>3</b> + CODE
Send a police alarm.	 Press and hold both POLICE buttons for 2 seconds.
Send an auxiliary alarm.	 Press and hold both AUXILIARY buttons for 2 seconds.
Send a fire alarm.	 Press and hold both FIRE buttons for 2 seconds.
Arm system with No Delay.	<b>2</b> + CODE + <b>4</b> or <b>3</b> + CODE + <b>4</b>
Bypass a sensor.	<i>Indirectly:</i> <b>2</b> + CODE + <b>#</b> + CODE or <b>3</b> + CODE + <b>#</b> + CODE  <i>Directly:</i> <b>#</b> + CODE + <i>Sensor Number</i>
Arm system silently.	<b>5</b> + <b>2</b> + CODE or <b>5</b> + <b>3</b> + CODE
Arm system with exit lights off.	<b>2</b> + CODE + <b>0</b> or <b>3</b> + CODE + <b>0</b>
Turn all lights on/off.	<b>0</b> + <b>0</b>
Turn specific lights on/off.	<b>0</b> + <i>Light number</i>
Output Control	<b>7</b> + <b>7</b> + <i>Output number</i>
Check the system status.	<b>*</b> for a short status report <b>*</b> + <b>*</b> for a long status report
Turn Chime on/off.	<b>7</b> + <b>1</b>
Disable local phone access. (This is a phone command only.)	<b>#</b> + <b>7</b> + <b>3</b>
Check Alarm Memory	<b>7</b> + <b>6</b>

## Contents

---

Getting to Know Your Security System .....	3
Overview .....	3
Communicating with the Panel .....	3
Instructing the Panel .....	4
How Your System Communicates with You .....	4
Fire and Smoke Alarms .....	4
Clearing Smoke Sensors .....	4
What Happens When There is an Alarm .....	4
Opening and Closing Reports .....	4
No Activity Feature .....	4
Arming Your System .....	5
Quick Arm .....	5
Level 1—OFF (DISARMED) .....	5
Keychain Touchpad Arming .....	5
Arming Level 2—HOME .....	5
Quick Exit .....	5
If leaving the premises, exit through a designated delay door immediately. ....	6
Arming Level 3—AWAY .....	6
Using the Chime Feature .....	6
Preventing Accidental Alarms .....	6
Aborting Accidental Alarms .....	6
Exit and Entry Delay Times .....	7
Extended Delay .....	7
Exit Extension .....	7
No Delay—For Instant Alarm .....	8
Auto HOME Arming Feature .....	8
Arming While a Door or Window is Open .....	8
Bypassing a Sensor Directly .....	8
Bypassing a Sensor Indirectly .....	8
To arm bypassed sensors .....	9
Was the Bypass Successful? .....	9
Basic Light Control .....	9
Basic Output Control .....	9
Checking the Status of Your System .....	9
Short System Status .....	9
Full System Status .....	10
System Alarm Sounds .....	10
Panic Alarms .....	10
Fire Panic .....	10
Police Panic Alarm .....	10
Auxiliary Panic Alarm .....	10
Siren Time-out .....	10
Access Codes .....	10
System Master Code .....	10
Partition Master Codes .....	10
Regular User Codes .....	10
Using the Programming Menus .....	11
Programming Access Codes .....	11
Setting the Time and Date .....	12
Adjusting System Sounds and Touchpad Brightness .....	12
Arming Your System Silently .....	12
Adjusting the Touchpad Display Brightness .....	12
Adjusting the Volume .....	12
Creating Time Schedules .....	12
Scheduling Consecutive Days .....	13
Attaching Time Schedules .....	13
Time Schedules and Partitions .....	14
Exception reports .....	13
In the Event of . . . .....	14
When Will this Feature Be Active? .....	14
Assigning a Time Schedule to Exception Opening and Closing 14 .....	14
Advanced Light Control .....	14
Controlling Lights By Time Schedule .....	14
Installer Programmable Lighting .....	14
Controlling Outputs by Time Schedule .....	14
Using the Installer Access Feature .....	15
Using a Partitioned System .....	15
Global Settings .....	15
Partition-Specific Settings .....	15
Jumping Partitions .....	15
Using the Panel Download Feature .....	15
System Information .....	16
Using a Touch Tone (or DTMF) Phone to Operate Your System	16
Phone Command Prefix .....	16
Accessing the System from Off-site .....	16
Touch Tone (or DTMF) Phone System Operation .....	17
Testing the System .....	18
Automatic Test Features .....	18
Manual Tests .....	18
Troubleshooting .....	19
Trouble Beeps and Trouble Messages .....	19
Common Concerns .....	19
Checking the Panel Fuse .....	19
Account Number .....	21
System Sensors .....	21
User Codes .....	22
Output Control .....	23
Lights .....	23
Touchpad Information .....	23
Accidental Smoke and Fire Alarms .....	24
Dialer Abort .....	24
Arming Information .....	25
Reporting .....	25
If the Power Goes Out .....	26
No Activity Time .....	26
System Information .....	26
Floor Plan Example .....	27
Your Floor Plan .....	27
Alarm System Limitations .....	27
If Your System Needs Service .....	28
Two Methods to Program Your System .....	29
Using Programming Menus .....	29
Using Programming Shortcuts .....	32
Notes: .....	35
Notices .....	36
Telecom Approval Notice .....	36
Notice of Network Compatibility .....	36
Electrical Requirements .....	36
Technical Service and Repair .....	36



# GETTING TO KNOW YOUR SECURITY SYSTEM

This manual describes how to operate your system. It describes basic arming and disarming commands as well as how to program system features.

The dealer or installer may have already discussed the details of your system with you. Record your system details in the User Sheets located in Appendix A.

## Overview

Your security system is made up of different parts. Each plays a special role in the system operation.

The **panel** is at the heart of your system. It stores the intelligence to monitor all the sensors and devices in the system. The panel activates sirens and initiates a call to the central station in an alarm situation. Your panel will have either a steel or plastic enclosure.

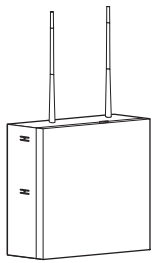

Steel

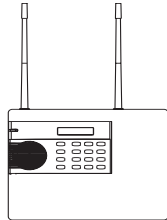

Plastic

**Touchpads** are used to arm, disarm, and program your system.

Your system may use a wall-mounted touchpad that looks like this.

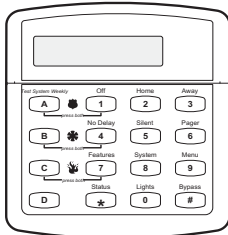

This touchpad is called an alphanumeric touchpad and communicates by displaying text on a two-line display.

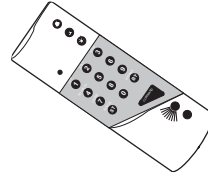

Your system may also use wireless, handheld touchpads that can be carried from room to room.

Keychain touchpads are also wireless and are handy for simple arming and disarming functions. Keychain touchpads can be carried off-site.



The installer can program the keychain touchpad to send a Police or Auxiliary panic alarm.



Wireless panic button touchpads are dedicated to sending one signal only—usually a Police or Auxiliary panic alarm. Panic button touchpads are usually kept near the user.

**Door and window sensors** protect the perimeter of your home by alerting the panel when a door or window is opened.

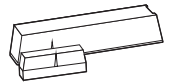

**Motion detectors** in hallways or rooms detect a person moving across the field of detection.

**Environmental sensors** such as smoke and heat detectors remain alert for the presence of fire 24 hours a day.



## COMMUNICATING WITH THE PANEL

Your system can be set up to communicate with you through

- Status beeps
- Alarm sirens
- Touchpad text



A sensor is activated.

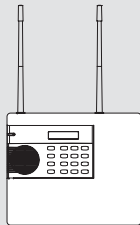

The sensor alerts the panel immediately.

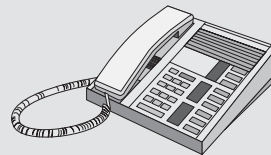

The panel activates sirens. If the system is monitored, the panel calls the central monitoring station.

This decision is based on system programming and the current arming level.



The central monitoring station operator reports the alarm to the police or fire department.



## Instructing the Panel

Not just anyone can walk up to a touchpad and operate your security system. Before the system will process most commands, users are required to enter a pre-programmed 5-digit access code. Access codes are discussed in detail on page 10.

Command + Access Code  

Keychain touchpads that are enrolled as part of the system do not require an access code, but are usually kept in an individual's pocket or purse.

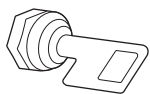

If you would rather use an actual key to arm and disarm the system, your security dealer can install a special key and keyswitch in your home.

## How Your System Communicates with You

Touchpads and interior sirens produce a variety of operating beeps to inform you of different system states and operations.

### Key Beeps

A “key beep” is the tone you hear when you press a button on a touchpad. The sound confirms that the button was pressed adequately. Key beeps can be turned on or off by the installer.

### Status Beeps

Status beeps from touchpads or sirens sound when there is a change in the current status of the system. Status beeps are not alarms, but they do warrant your attention.

There is more than one type of Status beep:

- Exit Delay beeps indicate that an arming command has been entered and the countdown to arming has begun.
- Entry Delay beeps indicate that you've entered the building and the countdown to an alarm has begun. (So disarm the system as soon as you get in!)
- Trouble beeps tell you that there is a problem with the system or one of its components.
- Chime feature beeps tell you that a door or window was opened.
- Protest beeps inform you that you're trying to arm the system while there is an open door or window.
- Sensor test beeps are the sound the system makes during a sensor test to indicate that a sensor was tested properly.

Status beeps are described in more detail throughout the manual.

## FIRE AND SMOKE ALARMS

If your system contains smoke and fire sensors, it monitors the premises for smoke and fire alarms 24 hours a day and in all arming levels.

These alarms cannot be cancelled or aborted and are *always* reported to the central station. Since many communities charge for dispatching the fire department in error, your dealer may give you specific instructions to follow in the event of an accidental

## What Happens When There is an Alarm

In the event of an alarm, several things happen at once:

- Sirens and hardwired touchpads emit emergency tones.
- The panel notifies the central station for help (if your system is monitored).
- A message appears on fixed text or alphanumeric touchpads.

## OPENING AND CLOSING REPORTS

The Opening and Closing Reports feature notifies the central station whenever the system is armed or disarmed.

The Opening and Closing Reports feature can be enabled only by the installer.

If the feature is on, the central station will receive the following reports:

- an Opening Report every time the system is disarmed.
- a Closing Report every time a user arms the system.

## NO ACTIVITY FEATURE

The system can monitor the activity in your home and automatically call for help if normal activities are not detected within a defined period of time.

**Note:** This feature is not active in Level 3—AWAY.

For example, if someone falls and can't move, the system will detect that normal activities, such as opening doors and windows, have not occurred for a predetermined No Activity time.

The system sounds an auxiliary alarm to let you know there may be a problem. If all is well, you can stop the siren by disarming your system. If no one disarms the system for 5 minutes, your system calls the central monitoring station. The central monitoring station will send emergency personnel to the premises to check out the situation.



Refer to the Appendix A User Sheets to see if the No Activity feature is currently available to you and the duration of the No Activity setting. If the feature is not currently available to you, contact your installer.

smoke or fire alarm. Record these instructions in the Appendix A User Sheets under “Accidental Smoke and Fire Alarms.”

## Clearing Smoke Sensors

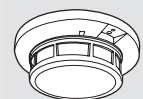
Once a smoke sensor is in alarm, it is considered “Open” or in “Trouble” until it is reset. For hardwired smoke detectors:



- Press  + Code once to silence the alarm.
- Press  + Code again to reset the smoke alarm.

## ARMING YOUR SYSTEM

Since your security needs may vary throughout the day, the system was designed with three arming levels. By arming your system to a particular level, only those sensors programmed to detect in that arming level will report alarms.

### Level 1—OFF (DISARMED)

Use Level 1 when intrusion detection is not necessary. For example, on an active Saturday morning—kids playing inside and out, someone working in the garage, various house projects going on.

Even though Level 1 disarms the system, your system continues to monitor for fire, smoke, carbon monoxide, and panic alarms (if your system has these devices installed).

#### *The Touchpad Tamper Feature*

The installer can program your system to send a Police alarm in the case of possible touchpad tampering.

If more than 40 keys are pressed when the system asks for a code, and those keystrokes are not part of a valid access code, a siren will sound.

Here are some other situations in which you would set the system to Level 1—OFF (DISARMED):

- *Upon entering your armed home or business.* When entering the armed premises through a designated delay door, the entry delay time begins. Entry Delay beeps remind you to disarm the system.
- *Before opening a door or window while inside or outside the armed home or business.* When you wake up in the morning and want to get your newspaper, you must disarm the system before opening the door to prevent an accidental alarm.

(See the section on “Preventing Accidental Alarms” on page 6 if you would like to be able to leave quickly when the system is armed.)

### QUICK ARM

Your system may be set up so that you’re able to arm the system without using an access code.

#### To use Quick Arm:

- Increase the arming level by simply pressing **2** or **3** at any touchpad.

Decreasing the arming level requires that the user enter a code.



Simply press **2** or **3** to increase the arming level. To decrease the arming level, you'll need to enter an access code.



Contact your dealer if you'd like to use this feature.

- *To stop sirens and cancel an alarm.* When an alarm condition occurs, disarming the system turns off any sirens.

#### To disarm to Level 1—OFF (DISARMED) using a touchpad:

1. Press **1**. Touchpads display “ENTER CODE.”
2. Enter your access code. Touchpads display date and time.
3. The system sounds one long beep.

### KEYCHAIN TOUCHPAD ARMING



To disarm your system with a keychain touchpad, press the Unlock button.



Your installer can set up your keychain touchpad to arm the system in one of two ways:



1. Press the Lock button to arm the system directly to Level 3 with no Entry or Exit delays. When using this method, you would not be able to arm to Level 2.
2. Press the Lock button to increase the arming level each time it is pressed (Level 1 to Level 2, or Level 2 to Level 3). The delay times would be applied.

### Arming Level 2—HOME

There are times when you want intrusion protection but still want the freedom to move around within your house without setting off an alarm — for example, in the evening when your family is inside for the night. In this and similar situations, arm your system to 2—HOME.

### QUICK EXIT

Your system may be set up so that when your system is armed to Level 2—HOME, you’re able to press **D** on any touchpad and simply walk out of the door without having to disarm and rearm the system. This is useful, for example, when your system is armed and you want to pop outside to pick up the newspaper without disarming your system.

**IMPORTANT:** If you step outside and are planning to come back in, do *not* close the door behind you!

#### To use Quick Exit:

1. When the system is armed to 2—HOME, press **D** at any touchpad. Opening the door without pressing **D** will cause an alarm.
2. Open the door and go outside.  
*Leave the door open if you are planning to come back in!*
3. Come back in within two minutes and close the door. The system will rearm to 2—HOME.

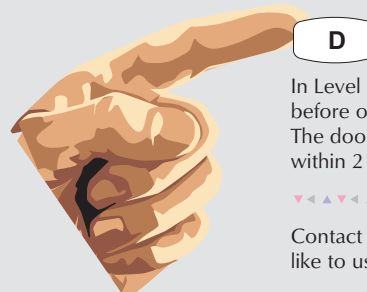

In Level 2—HOME, simply press **D** before opening the door. The door must be closed again within 2 minutes to avoid alarm.



Contact your dealer if you'd like to use this feature.

To arm to Level 2—HOME using a touchpad:

1. Close all protected perimeter doors and windows.
2. Press **[2]** at any touchpad. Touchpads display, "ENTER CODE."
3. Enter your access code. Touchpads display, "ARMED TO HOME."
4. The system sounds two short beeps.

If leaving the premises, exit through a designated delay door immediately.

## Arming Level 3—AWAY

At other times, you want every sensor to be alert: When the family is away from home, or, in a business, after closing time.

In this and similar situations, set your system to 3—AWAY for maximum protection. All sensors are active—perimeter door and window sensors, and interior motion detectors.

### To arm to Level 3—AWAY using a touchpad:

1. Close all protected doors and windows.
2. Press **[3]** at any touchpad. Touchpads display, "ENTER CODE."
3. Enter your access code. Touchpads display, "ARMED TO AWAY."
4. The system sounds three short beeps.
5. Exit through a designated delay door immediately.

## USING THE CHIME FEATURE

Turning on the Chime feature is like having bells on every protected door and window. When this feature is on, sirens and speakers sound 2 beeps whenever anyone opens a protected door or window.

The Chime feature works only in Level 1—OFF (DISARMED).

### To turn Chime on/off:

- While in Level 1—OFF (DISARMED), from any touchpad, press **[7]** + **[1]**.  
While the Chime feature is on, the touchpad display alternates between "CHIME IS ON" and the time and date. When the Chime feature is off, only the time and date are displayed.

When the system is armed again, Chime becomes deactivated.

### *Chime-On-Close*

The Chime-On-Close feature works like the regular Chime feature, but in addition to the double beeps heard upon opening a protected door or window, the system sounds one long beep when the door or window is closed again.

You can turn the Chime-On-Close feature on or off from the programming menu. Refer to Appendix C, "Programming Menus" for information on programming your system.

### *Using the Voice Chime Feature*

If you have a Phone Interface/Voice module and the installer wired speakers to the module outputs, you can program your system to speak the programmed sensor text whenever someone opens a

protected door or window. Refer to Appendix C, "Programming Menus" for information on programming your system.

## PREVENTING ACCIDENTAL ALARMS

Your security system is engineered with advanced technology that reduces the chance of an accidental alarm caused by a technical problem. In wireless systems, this technology prevents other devices (such as garage door openers, ham radios, television remote controls, and cellular phones) from interfering with your security system.

Most accidental alarms occur when leaving the house after arming the system, or upon returning, before disarming the system.

If, for example, you arm the system then run upstairs for something you forgot, the Exit Delay time may expire. Once the Exit Delay expires, opening an armed door or moving in front of a motion detector will cause an alarm.

## Aborting Accidental Alarms

Your system can be set up with the opportunity to abort an accidental intrusion, Police, or Auxiliary alarm. (Fire alarms caused by smoke sensors, fire panic alarms, and heat sensors cannot be aborted.)

If the Dialer Abort feature is turned on, disarming the system (thus aborting the alarm) within a specified time period will silence the siren and prevent the alarm from being reported to the central monitoring station.

Aborting a fire alarm will silence the siren; however, fire alarms are *always* reported. If an accidental fire alarm has sounded, follow the procedures of your central monitoring station to prevent a false dispatch.

### To cancel an alarm:

- Press **[1]** + Code.



## Guidelines for Preventing Accidental Alarms

Following these guidelines will go a long way toward preventing accidental alarms.

- ③ Close doors and windows before you leave your house.
- ③ When getting ready to leave the house, gather the things you want to take with you so you can exit immediately after arming the system.
- ③ Always enter and exit within the programmed delay times.
- ③ Make sure you leave through a door that has a delay time set for it. If you arm your system then leave through a door without a delay time, an alarm will immediately sound.
- ③ When you return, immediately disarm your system.
- ③ Be aware of the devices in your security system and learn how each one operates.
- ③ Listen to system beeps. Take note of any touchpad messages which indicate the current system status.
- ③ If you have pets, ask your installer if you need pet lenses in your motion detectors. Pets climb higher than you may guess, causing alarms when you are away.
- ③ Check the location of your smoke detectors. Smoke detectors near bathrooms can be tripped by steam from a shower. Smoke detectors near the kitchen can be tripped by cooking smoke.

Refer to the User Sheet in Appendix A to determine what the specific settings are for your system.

## EXIT AND ENTRY DELAY TIMES



After arming your system, you need time to exit the building so you won't set off an alarm. Likewise, upon returning to your home or business, you'll need enough time to open the door and get to a touchpad to disarm the system.

- The *Exit Delay* is a period of time long enough to let you leave through a designated delay door after arming the system.
- The *Entry Delay* is a period of time long enough to let you unlock a designated delay door and get to a touchpad to disarm the system.

### Exit Delay Example

You're about to go on an errand. You are inside your house and have just armed the system to Level 3—AWAY.

The interior sirens and touchpads sound three quick status beeps, telling you that the system accepted the command and has started the Exit Delay time.

During the Exit Delay time, the system sounds one short beep every 4 seconds. During the last seconds of the delay time, the beeps will accelerate to one per second. Exit the premises immediately.

At the end of the Exit Delay, you'll hear three more quick status beeps. These beeps indicate that the Exit Delay has ended.

### Important!

When the Exit Delay expires, the system is armed. Opening a door at this point will cause the entry delay to start. If the Exit Delay time expires before you can exit, you must disarm and re-arm the system before exiting.



After arming, you'll hear 3 quick status beeps.

During the Exit Delay, you'll hear one beep every four seconds.  
**Leave the premises now.**

3 quick status beeps sound when the system is armed.

### Entry Delay Example

You are returning to your house that is armed to Level 3—AWAY. When you unlock and enter the designated delay door, the interior sirens and touchpads sound two short beeps every two seconds. This tells you that the Entry Delay time has begun and reminds you to disarm the system to avoid setting off an alarm.

During the last 10 seconds of Entry Delay, you'll hear the double-beeps every second. If the system is not disarmed before the Entry Delay time expires, the panel will trigger an alarm.

Your installer will work with you to decide which door(s) should be a delay door(s) and determine the delay times that will work best for you and your family. Then, the installer will program the Exit and Entry Delay times into your system.



Upon entering, during the Entry Delay, you'll hear 2 beeps every 2 seconds.

Disarm the system before the last of 10 quick status beeps to avoid an accidental alarm.

## Extended Delay

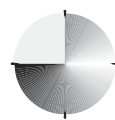

In some situations, additional time is needed to arm or disarm the system from, for example, a protected outside gate or door. In these instances, the installer can program an extended delay, giving as much as 16 minutes to exit or disarm the system before setting off an alarm.

Refer to the Appendix A User Sheets "Delay Doors and Delay Time Settings" for a list of actual exit delay times.

## Exit Extension

Your system may be set up so that the delay time is restarted if you re-open the delay door during the initial delay time.

This is useful if, after arming the system, you walk out the door, then remember something you forgot inside. You can re-enter and exit through the delay door without disarming and re-arming the system.

**Note:** The Exit Extension will work on the first re-entry only.

If your system is not using this feature, you must disarm the system when you re-enter the armed premises to avoid setting off an alarm.

## No Delay—For Instant Alarm



You can choose to turn off the Entry and Exit Delays, causing the delay doors to arm immediately. Anyone entering the house through the delay door when the system is set to No Delay would immediately cause an alarm.

No Delay is normally used...

- When you're not planning to leave after you've armed the system (such as when you arm the system to Level 2).
- When you're arming and disarming your house from the outside. (You must have a wireless touchpad in order to do this.)

### Arming to Level 2 or 3 with No Delay:

1. Close all perimeter doors and windows.
2. Exit the premises if arming to Level 3—AWAY.
3. Enter:  $\boxed{2}$  + Code or  $\boxed{3}$  + Code.  
The system sounds two or three short beeps.
4. Immediately after hearing the beeps, press  $\boxed{4}$  for No Delay. Touchpads display, "ARMED TO HOME NO DELAY" or "ARMED TO AWAY NO DELAY."

Changing the arming level will restore delay doors to their normal Exit and Entry Delay times.

## Auto HOME Arming Feature

The Auto HOME Arming feature helps cut down on false alarms in the event that you arm the system to 3—AWAY, but fail to leave during the exit delay time. Here's how it works.

<i>If you arm the system to Level 3—AWAY, and do not leave the premises within the exit delay time—</i>	
<b>If feature is turned on</b>	The system can tell that no one opened and closed a delay door within the delay time. It assumes that someone is still inside and the panel will arm to 2—HOME to avoid a false alarm.
<b>If feature is turned off</b>	The system arms to Level 3—AWAY regardless of whether or not a delay door has been opened and closed. Your movement inside the premises could activate a motion detector, causing an alarm.

Your dealer can turn this feature on or off for you.

## ARMING WHILE A DOOR OR WINDOW IS OPEN

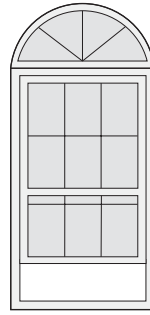

It is possible to arm your system while leaving a door or window open, but your user code must have the Direct Bypassing attribute. (See "Assigning the Direct Bypassing Attribute" on page 11.)

This is useful if, for example, you like to sleep at night with the window open.

If the door or window has a sensor installed on it, the system must be told to ignore, or *bypass*, that sensor when it's open. All other sensors will remain active.

There are two methods for bypassing a sensor:

- **Directly** — After arming the system, bypass door/window sensors *before* you open them. You must know the sensor number of the door or window you wish to bypass.
- **Indirectly** — As you are arming, bypass sensors on already-open doors and windows by pressing the BYPASS button and entering your 5-digit code.

### REMEMBER:

When a sensor is bypassed, you are allowing that door or window to be unprotected.

## Bypassing a Sensor Directly

Use this method if the system is armed and you would like to open a window without disarming.

**Note:** You cannot bypass sensors directly using a keychain touchpad.

Refer to the Appendix A User Sheets to determine what the sensor number is for the sensor you wish to bypass.

### To bypass sensors *directly*:

1. Close all doors and windows.
2. Arm your system to the desired level.
3. At any touchpad, press  $\boxed{\#}$  + Code + sensor number. ( $\boxed{\#}$  is labeled *Bypass*)
4. Touchpads display "SENSOR 01 BYPASSED," for example.

**Note:** If the touchpad displays "INVALID," or if the touchpad sounds one long beep, make sure that you entered the sensor number of a door or window sensor. Heat and smoke sensors cannot be bypassed, so entering a heat or smoke sensor number would cause the "invalid" message and beep.

5. Bypass other sensors, if necessary, by repeating Step 3.
6. The bypassed door or window can now be opened.

## Bypassing a Sensor Indirectly

Use this method if you are arming the system and would like to bypass doors and windows already open.

**To bypass sensors indirectly:**

1. Leave open only those doors and windows that are to remain open. Close all others.
2. Arm your system to the desired level. The touchpad emits protest beeps and displays "PROTEST" because of the open sensor(s).
3. At any touchpad press BYPASS. Touchpads with displays show, "ENTER CODE." Enter the code and the display shows "SENSOR NN BYPASSED" (nn is the sensor number).
4. The system sounds arming level beeps to indicate that the system is armed and open sensors have been successfully bypassed.

**To bypass sensors indirectly using a keychain touchpad:**

- Press the Lock button once to arm the system and again to bypass open sensors.

**To arm bypassed sensors**

If you bypass sensors (directly or indirectly) and then decide you want to arm those sensors, you can disarm and re-arm the system

OR

At any touchpad, press BYPASS (the  key) + Code + the sensor number. Touchpad displays will show "SENSOR NN UNBYPASSED" (NN is the sensor number).

**Was the Bypass Successful?****To confirm whether or not a sensor was bypassed:**



- Press the Status button on the touchpad. ( is labeled *Status*.) Touchpads with displays list bypassed sensors or zones.

**BASIC LIGHT CONTROL**

There are two kinds of light control:

- *Basic* light control, offering instant light control at any touchpad.
- *Advanced* light control, in which lights turn on and off automatically according to specific situations. See "Advanced Light Control" on page 14.

**To turn all lights on or off:**

- From any touchpad  
Press  + .
- From a 4-button keychain touchpad

Press  (the LIGHTS button).

**To turn a specific light on or off\*:**

- From any touchpad, press  + light number.

You cannot turn on a specific light using a keychain touchpad.

\* Refer to the User Sheets in Appendix A to determine which light number is associated with which lamp.

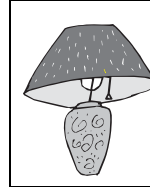



For system lights to respond to basic and advanced light commands, the light switches must be turned on.

**BASIC OUTPUT CONTROL**

Panel output points control the hardware installed on your system. These outputs are usually configured to turn on automatically in response to certain events.

Your installer may have configured your system so that you can control some output points from your touchpad. Have the installer list and explain any outputs that are programmed for your control (see "Output Control" on page 23). Use the following procedure to turn an output on or off.

**To turn the output on or off:**

- From any touchpad, press  +  + output number. If the output was activated, it will shut off. If the output was off, it will activate.

**CHECKING THE STATUS OF YOUR SYSTEM**

Checking the system status means finding out about the current condition of your system. This includes finding out if any sensors are open or currently bypassed, whether or not the AC power and backup battery are okay, the nature of the most recent alarm, and more depending on the features in use and the equipment in your system.



Check the system status if

- Your system sounds trouble beeps (five short beeps every minute).
- Your touchpads display a blinking .

**Short System Status**

A Short Status indicates the current arming level, sensor status (whether open or bypassed), low battery, supervisory, AC power or backup battery failures.

**To get a Short System Status:**

- Press . ( is labeled *Status*.) The system sounds beeps according to the current arming level. (One for Level 1, two for Level 2, three for Level 3.) Touchpads display the status information. For example, "SYSTEM IS OK," or "SENSOR 02 OPEN."



If an alarm or system trouble condition has occurred, it is displayed on a touchpad the first time you perform a Short or Full Status check. Performing a system status check a second time displays the system status including any trouble conditions.

If any alarm or system trouble is active, it continues to show up in every status check until the system is disarmed.

## Full System Status



A Full Status combines the Short Status information with added details about specific system features.

### To get a Full System Status:

- Press  + . Interior sirens sound beeps according to the current arming level. Touchpads display the status information, such as "SENSOR 03 BYPASSED," "SYSTEM BATTERY IS OK," "AC POWER IS OK."

## System Alarm Sounds

The sirens and touchpads in your system emit alarm sounds whenever an alarm occurs, either by a sensor or panic button activation. Each type of alarm sounds and reacts differently when activated, as described in the following table.

Type of Alarm	Alarm Sound
 <b>Fire</b>	Repeating series of three beeps
 <b>Police</b>	Continuous tone
 <b>Auxiliary</b>	Rapid beeps

## PANIC ALARMS

Panic alarms are easily activated from any touchpad to quickly alert the central monitoring station to a Fire, Police, or Auxiliary emergency. A panic alarm can be activated at any time, regardless of the current arming level: 1—OFF (DISARMED), 2—HOME, or 3—AWAY.

This system is designed to inform a central monitoring station of the nature of the emergency so the correct personnel can be dispatched immediately.

### Fire Panic

The Fire panic alarm sounds from all interior and exterior sirens. On monitored systems, the central monitoring station responds by calling the fire department.

#### To activate a Fire panic alarm from a touchpad:

- Press and hold the  Fire button for 2 seconds.



### Police Panic Alarm

The Police panic alarm sounds from all interior and exterior sirens, scaring off any intruder and alerting neighbors to the trouble. On monitored systems, the central monitoring station responds by calling the police.

#### To activate a Police panic alarm using a touchpad:

- Press and hold the  Police button(s) for 2 seconds.

#### To activate a Police panic alarm from a keychain touchpad\*:

- Press and hold the  Lock and  Unlock buttons at the same time for 2 seconds.
- \* The installer must configure the Police panic alarm to work this way.

## Auxiliary Panic Alarm

The Auxiliary panic alarm sounds from interior sirens only. It is typically set up by your security dealer, based on your specific needs. On monitored systems, the central station responds by calling the service or agency you specified through your dealer.

#### To activate an Auxiliary panic alarm from a touchpad:

- Press and hold the  Auxiliary button(s) for 2 seconds.

#### To send an Auxiliary panic alarm from a keychain touchpad:

- Press and hold the  Light and  Star buttons at the same time for 2 seconds.

## Siren Time-out





If the system is not disarmed after an alarm, the sirens will continue to sound until the time-out period is reached. The time-out period can be programmed only by your installer or dealer.

**Note:** If your system is monitored, the central station will consider the alarm in progress until the system is manually disarmed, whether the sirens have timed out or not.

## ACCESS CODES

The system requires a valid access code before it will process most commands. The Appendix A User Sheets provide a location for you to record the System Master and User codes.

### System Master Code

There is one **System Master** code. The System Master code is used to enter the programming menus for your system. The default System Master code is . It is important that you change the default code and record the new code in the Appendix A User Sheets.

### Partition Master Codes

There are two **Partition Master** codes, one for each partition, that allow access to system operations for that partition.

### Regular User Codes

There are 43 **Regular User** codes that act like keys to arm and disarm one partition of the system. If necessary, they can be assigned to neighbors, baby-sitters, or repair persons for temporary use. Regular user codes can be changed in the programming menus and are easily deleted from the system when no longer necessary.

**Note:** Any user who is assigned the Partition Jump attribute will

need two user codes, one for each partition.

**Good User Code Hygiene**

To preserve the integrity of your system, keep user codes confidential and delete extra codes as soon as they are no longer needed.

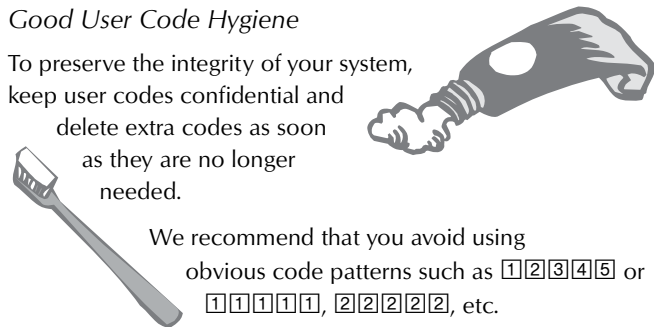

We recommend that you avoid using obvious code patterns such as 12345 or 11111, 22222, etc.

## Using the Programming Menus

Some system settings can be changed by you, the user, while other settings must be changed by the installer.

To change system settings, you'll use the System Master code or the Partition Master code to enter a series of programming menus. Appendix C gives a detailed explanation of how to use the menus or, if desired, how to use programming shortcuts.

## Programming Access Codes

User codes can be given certain attributes which determine whether the user can bypass a sensor or perform system tests.

### Changing a User Code

#### To change or assign a user access code:

1. Enter the programming menus by pressing  $\text{9} + \text{System or Partition Master Code}$ .
2. Press  $\text{10} \text{N} \text{N} \text{0}$  where  $nn$  is user 00 through 42.
3. Enter the desired 5-digit code, then  $\#$ .
4.  $\text{*} + \text{6} + \text{\#}$  to exit the programming menus.

**Note:** The system will not accept the same code for two different users in the same partition. However, two users in different partitions can have the same user code. This is useful if a user with the partition jumping attribute wants to have the same user code for both partitions.

### Erasing a User Code

When a code is deleted from the system, that code no longer acts as a key for operating the system in any manner.

#### To erase a user code:

1. Enter the programming menus by pressing  $\text{9} + \text{System or Partition Master Code}$ .
2. Press  $\text{10} \text{N} \text{N} \text{0}$  where  $nn$  is user 00 through 42.
3. Enter the System or Partition Master code, then  $\#$ .
4.  $\text{*} + \text{6} + \text{\#}$  to exit the programming menus.

### Assigning the Direct Bypassing Attribute

Direct Bypassing is a user code attribute that allows the user to bypass open sensors. If the user code does not have this attribute turned on, the user will not be able to bypass sensors directly.

#### To assign Direct Bypassing to a user:

1. Enter the programming menus by pressing  $\text{9} + \text{System or Partition Master Code}$ .
2. Press  $\text{10} \text{N} \text{N} \text{1}$  where  $nn$  is user 00 through 42.
3. To turn Direct Bypassing on, press  $\text{2} + \text{\#}$ . To turn Direct Bypassing off, press  $\text{1} + \text{\#}$ .
4. Press  $\text{*} + \text{6} + \text{\#}$  to exit the programming menus.

### Assigning the Remote Access Attribute

Remote Access is a user code attribute that allows the user to access the security system from a telephone. If the user code does not have this attribute turned on, the user will not be able to access the system by telephone.

#### To assign Remote Access to a user:

1. Enter the programming menus by pressing  $\text{9} + \text{System or Partition Master Code}$ .
2. Press  $\text{10} \text{N} \text{N} \text{2}$  where  $nn$  is user 00 through 42.
3. To turn Remote Access on, press  $\text{2} + \text{\#}$ . To turn Remote Access off, press  $\text{1} + \text{\#}$ .
4.  $\text{*} + \text{6} + \text{\#}$  to exit the programming menus.

### Assigning the Partition Jump Attribute

Partition Jump is a user code attribute that allows the user to access both partitions. If the user code does not have this attribute turned on, the user will only have access to one partition.

**Note:** A user with the Partition Jump attribute will need two user codes, one for each partition. The codes can be identical, but must be programmed for separate partitions.

#### To assign Partition Jump to a user:

1. Enter the programming menus by pressing  $\text{9} + \text{System or Partition Master Code}$ .
2. Press  $\text{10} \text{N} \text{N} \text{3}$  where  $nn$  is user 00 through 42.
3. To turn Partition Jump on, press  $\text{2} + \text{\#}$ . To turn Partition Jump off, press  $\text{1} + \text{\#}$ .
4.  $\text{*} + \text{6} + \text{\#}$  to exit the programming menus.

### Assigning the System Test Attribute

System Tests is a user code attribute that allows the user to perform system tests. If the user code does not have this attribute turned on, the user will not be able to perform phone or sensor tests.

#### To assign the System Testing to a user:

1. Enter the programming menus by pressing  $\text{9} + \text{System or Partition Master Code}$ .
2. Press  $\text{10} \text{N} \text{N} \text{4}$  where  $nn$  is user 00 through 42.
3. To turn System Testing on, press  $\text{2} + \text{\#}$ . To turn System Testing off, press  $\text{1} + \text{\#}$ .
4.  $\text{*} + \text{6} + \text{\#}$  to exit the programming menus.

## SETTING THE TIME AND DATE

Although the installer usually sets the time and date at the time of installation, the user can change it when necessary. See Appendix C, “Programming Your System” for more detailed information on setting this feature.

### To set the system time:

1. Enter the programming menus by pressing **[9]** + *System or Partition Master Code*.
2. Press **[0]** + **[0]**.
3. Enter the correct time in 24-hour format (4 digits), then press **[#]**.  
For example, if the current time is 7:23 a.m., press **[0]****[7]****[2]****[3]** + **[#]**.
4. Press **[\*]** + **[6]** + **[#]** to exit the programming menus.

### To set the system date:

1. Enter the programming menus by pressing **[9]** + *System or Partition Master Code*.
2. Press **[0]** + **[1]**.
3. Enter the current date as 6 digits (dd/mm/yy) then press **[#]**.
4. Press **[\*]** + **[6]** + **[#]** to exit the programming menus.

## ADJUSTING SYSTEM SOUNDS AND TOUCHPAD BRIGHTNESS

### Arming Your System Silently

Use the Silent Arming feature to arm your system without disturbing people throughout the house with arming status beeps. There are two methods for implementing Silent Arming.

- Silent on Demand (User presses **[5]** before arming)
- Arming Always Silent (Silent Arming feature on)

Regardless of the method employed, when Silent Arming is in effect no Exit beeps sound.

**Note:** Protest beeps will always sound when indirectly bypassing a sensor.

#### *Silent Arming on Demand*

Pressing **[5]** before arming silences arming status beeps from touchpads and interior sirens.

### To use Silent Arming on demand:

1. From any touchpad, press **[5]**.
2. Within 4 seconds enter: **[2]** + *Code* or **[3]** + *Code*.

#### *Arming Always Silent*

Turning this feature on in the programming menu means that the status beeps that come from touchpads and interior speakers while arming will *always* be silent. You will not have to enter **[5]** before arming, as with Silent Arming on Demand.

See Appendix C, “Programming Your System” for more detailed information on setting this feature.

### To enable Silent Arming:

1. Enter the programming menus by pressing **[9]** + *System or Partition Master Code*.
2. Press **[4]** + **[2]**.
3. To turn Silent Arming on, press **[2]** + **[#]**. No system status beeps will sound while arming.  
To turn Silent Arming off, press **[1]** + **[#]**. System status beeps will sound from touchpad while arming.
4. Press **[\*]** + **[6]** + **[#]** to exit the programming menus.

## Adjusting the Touchpad Display Brightness

You may want to change the brightness of a touchpad display based on its location in a building or room. For example, dim the touchpad display in a bedroom or enhance a display near a window.

Changing the touchpad display affects only the touchpad currently being used.

### To change touchpad display brightness:

1. Enter the programming menus by pressing **[9]** + *System or Partition Master Code*.
2. Press **[4]** + **[3]**.
3. Select a brightness level:
  - **[0]** + **[#]** Off
  - **[1]** + **[#]** Low
  - **[2]** + **[#]** Medium
  - **[3]** + **[#]** High
4. Press **[\*]** + **[6]** + **[#]** to exit the programming menus.

After dimming the display, pressing any button momentarily returns the display to full brightness. After 15 seconds without touchpad activity, the display returns to the set dimmed level. If an alarm occurs while the display is dimmed, it automatically returns to the full brightness level and stays that way until you disarm your system.

## Adjusting the Volume

If your system includes a phone and voice module, you can adjust the volume of the system sounds.

### To change system sounds volume:

1. Enter the programming menus by pressing **[9]** + *System or Partition Master Code*.
2. Press **[4]** + **[4]**.
3. Select a volume level from 0-7. Select **[1]** + **[#]** for the lowest sound level, select **[7]** + **[#]** for the loudest sound level.
4. Press **[0]** + **[#]** to turn sounds Off.
5. Press **[\*]** + **[6]** + **[#]** to exit the programming menus.

## CREATING TIME SCHEDULES

Time schedules are windows of time defined by a start time, a stop time, and the days of the week these times are effective.

You can create up to 16 time schedules for setting up the following system features: exception opening, exception closing, light control, and outputs.

**Note:** A Touch Tone (or DTMF) phone can be used to create time schedules, but an alphanumeric touchpad works much bet-

ter because of its extensive feedback.

### To define a time schedule:

1. At an alphanumeric touchpad, enter User Programming by pressing **[9]** + System or Partition Master code.
2. Press **[B]** until the touchpad displays "SET UP SCHEDULES," then press **[#]**. The touchpad displays the first time schedule, "SCHEDULE 00."
3. Press **[B]** until the touchpad displays the time schedule you wish to set, then press **[#]**. The touchpad displays the current start time for this schedule.
4. Enter the start time in 24-hour format (00:00–23:59), then press **[#]**. The touchpad displays the new start time.
5. To display the current stop time for this schedule, press **[B]** once.
6. Enter the stop time in 24-hour format, then press **[#]**. The touchpad displays the new stop time.
7. Press **[B]** until the touchpad displays a day of the week to which you wish to assign this schedule.
8. Enter **[2]** to include the day in the schedule ("ON") or **[1]** to exclude the day from the schedule ("OFF").
9. Press **[#]** to secure your choice.
10. Press **[B]** to move to the next day of the week or press **[\*]** to return to the schedule list.
11. Press **[\*]** + **[6]** + **[#]** to exit User Programming.

1	= Off
2	= On

## Scheduling Consecutive Days

There may be instances when you'd like to schedule a feature event to start one day and stop the next day or a number of days later.

### One Day Rollover

You can create a schedule that begins on one day, and stops the next day by using only one time schedule. (The stop time must be within 24 hours of the start time.)

#### Example 1 of One Day Rollover.

At home you'd like the front entry light to be on from 10 p.m. on Tuesday until 5 a.m. on Wednesday.

By taking advantage of One Day Rollover, one time schedule can cover both days. (That schedule is illustrated at right.)

Notice how the stop time is within 24 hours of the start time. The system knows to apply the stop time to the next day (5 a.m. on Wednesday).

	Schedule X
Start	22:00
Stop	05:00
Mon	OFF
Tue	ON
Wed	OFF
Thur	OFF
Fri	OFF
Sat	OFF
Sun	OFF
Part.	1

#### Example 2 of One Day Rollover.

Building on Example 1, let's say that you'd like the front entry light to be on between 10 p.m. and 5 a.m., Monday through Friday (ending Saturday morning).

By simply applying the start and stop times to each day, one time schedule can cover the entire week.

	Schedule X
Start	22:00
Stop	05:00
Mon	ON
Tue	ON
Wed	ON
Thur	ON
Fri	ON
Sat	OFF
Sun	OFF
Part.	1

### Multiple Day Rollover

The simplest method for defining a window of time that spans multiple days is to use 99:99 to signify an open start or stop time.

#### Example of Multiple Day Rollover.

At your business you'd like specific lights to remain lit from Friday afternoon through the weekend until Monday morning.

In this situation, the lights need to be scheduled to roll over until they reach a recognizable stop time.

In the figure to the right, Schedule Y is set up to begin at 4 p.m. on Friday afternoon. Since the stop time is 99:99, the lights will remain lit (roll over) until a recognizable stop time is reached.

Schedule Z is set up with an undefined start time (99:99), so if the lights were already lit, they will remain lit until the Schedule Z stop time is reached at 5 a.m.

	Schedule Y	Schedule Z
Start	16:00	99:99
Stop	99:99	05:00
Mon	OFF	ON
Tue	OFF	OFF
Wed	OFF	OFF
Thur	OFF	OFF
Fri	ON	OFF
Sat	OFF	OFF
Sun	OFF	OFF
Part.	1	1

## Attaching Time Schedules

For any schedule to be effective, it needs to be *attached* to a feature. One schedule can be attached to more than one feature event.

## Time Schedules and Partitions

Once a schedule is attached to a feature event in one partition, that schedule becomes unavailable to the other partition. This prevents the situation where one partition changes a time schedule that inadvertently affects both partitions.

## EXCEPTION REPORTS

Exception Reports notify the central station when arming or disarming occurs outside of specified time schedules.

### In the Event of . . .

You can set up the Exception Reports feature to notify the central station in the following instances:

- If the system is disarmed before the Opening time schedule begins or after the Opening time schedule has ended (*Exception Opening*).
- If the system is armed before the Closing time schedule begins or after the Closing time schedule has ended. (*Exception Closing*).

### When Will this Feature Be Active?

The most typical setup of this feature makes use of both Exception Opening and Exception Closing. It is possible to use Exception Opening only or Exception Closing only, however.

### Assigning a Time Schedule to Exception Opening and Closing

Follow these steps to define Opening and Closing schedules for Exception reports.

**Note:** A Touch Tone (or DTMF) phone can be used to set up Notify by Exception, but touchpads work much better because of their extensive feedback. See Appendix C for touchpad and phone programming instructions.

#### Scheduling Exception Opening and/or Closing:

1. At an alphanumeric touchpad, enter the programming menus by pressing **[9]** + System or Partition Master code.
2. Press **[B]** until the touchpad displays “ATTACH SCHEDULES TO EVENTS,” then press **[#]**.
3. To schedule Exception Opening, press **[A]** or **[B]** until the touchpad displays “EXCEPTION OPENING,” then press **[#]**. To schedule Exception Closing, press **[A]** or **[B]** until the touchpad displays “EXCEPTION CLOSING,” then press **[#]**.
4. The touchpad displays the first available time schedule.
5. Enter **[2]** to assign the time schedule or **[1]** to make the time schedule inactive for this event.
6. Press **[#]** to secure your choice.
7. Press **[B]** to go to the next schedule and repeat steps 4 and 5.

When you’ve finished attaching the desired time schedules, press **[\*] + [6] + [#]** to exit the programming menus.

## ADVANCED LIGHT CONTROL



You can control system lights from any touchpad, as discussed in “Basic Light Control” on page 9.

There are other lighting options that you or your installer can set up, including

- Turning lights on and off according to a time schedule.
- Turning lights on after system arming for the

duration of the Exit Delay.

- Turning lights on for the duration of the Entry Delay so you have enough light to see your way to the touchpad to disarm the system.
- Flashing lights on and off upon successful arming and disarming.

## Controlling Lights By Time Schedule

Lights can be turned on according to time schedules. If you need assistance setting up a time schedule that fits your lighting needs, see “Creating Time Schedules” on page 12.

#### To schedule lights:

1. At an alphanumeric touchpad, enter User Programming by pressing **[9]** + System or Partition Master code.
  2. Press **[B]** until the touchpad displays “ATTACH SCHEDULES TO EVENTS,” then press **[#]**.
  3. Press **[B]** until the touchpad displays “LIGHTS,” then press **[#]**.
  4. Press **[B]** until the touchpad displays the light number you would like to schedule. (Refer to the User Sheets in Appendix A to determine which light number is associated with which lamp.)
  5. Press **[#]**. The touchpad displays the first available time schedule.
  6. Enter **[2]** to assign the time schedule (“ON”) or **[1]** to make the time schedule inactive (“OFF”) for this light.
- |            |       |
|------------|-------|
| <b>[1]</b> | = Off |
| <b>[2]</b> | = On  |
7. Press **[#]** to secure your choice.
  8. Press **[B]** to go to the next time schedule, if needed, and turn the schedule on or off for this light.
  9. When you’ve finished attaching the desired time schedules, press **[\*] + [6] + [#]** to exit User Programming.

## Installer Programmable Lighting

If you would like specific lights to turn on during Entry and Exit Delay times, or if you would like a light to flash to indicate successful arming and disarming, contact your installer

## Controlling Outputs by Time Schedule

Outputs may be used to control devices in your home such as automatic window blinds. Outputs that your installer has enabled can be turned on or off according to time schedules.

#### To schedule outputs:

1. At an alphanumeric touchpad, enter the programming menus by pressing **[9]** + the System or Partition Master code.
2. Press **[B]** until the touchpad displays “OUTPUTS,” then press **[#]**.
3. Press **[B]** until the touchpad displays the output number you would like to schedule. Refer to the User Sheets in Appendix A to determine which output is associated with which output number.
4. Press **[#]**. The touchpad displays the first available time schedule.
5. Enter



- $\boxed{2} + \boxed{\#}$  to assign the time schedule (“ON”) for this output.
  - $\boxed{1} + \boxed{\#}$  to make the time schedule inactive for this output.
6. Press  $\boxed{0}$  to go to the next time schedule, if needed, and turn the schedule on or off for this output.
  7. When you’ve finished attaching the desired time schedules, press  $\boxed{*} + \boxed{0} + \boxed{\#}$  to exit the programming menus.

## USING THE INSTALLER ACCESS FEATURE

Once your system is installed, no one can access the installed panel programming unless you turn on the Installer Access feature. Occasionally, you may request that your dealer send an installation engineer to change system programming. The engineer will not be able to implement requested changes until you turn on the Installer Access Feature.

### To turn the Installer Access feature on or off:

1. Enter the programming menus by pressing  $\boxed{0} + \text{System or Partition Master Code}$ .
2. Press  $\boxed{4} + \boxed{0}$ .
3. To turn Installer Access on, press  $\boxed{2} + \boxed{\#}$ . The engineer will be able to change the installed programming of your system. To turn Installer Access off, press  $\boxed{1} + \boxed{\#}$ . No one will be able to access the installed programming of your system.
4. Press  $\boxed{*} + \boxed{0} + \boxed{\#}$  to exit the programming menus.

## USING A PARTITIONED SYSTEM

The panel can be set up by your installer to operate as a *two-partitioned system*. A partitioned system would be useful in a strip mall or residential duplex where two stores or households could share one system.

**Note:** If your system uses just one partition, skip this section.

### Global Settings

Global system settings affect both partitions. Most are set by the installer. Global settings that are programmed by the user include the time and date and the System Master code.

### Partition-Specific Settings

Partition-specific settings affect only one partition. User-programmable, partition-specific settings include

- Partition Master codes  
(1 per partition for a total of 2).
- A pool of 43 Regular User codes for use by one or the other partition. (Partition 1 Regular User codes + Partition 2 Regular User = 43 Regular User codes)
- A pool of 16 time schedules available to one or the other partition. (Partition 1 time schedules + Partition 2 time schedules = 16 time schedules)
- The Silent Arming option.
- Speaker volume settings.

To program any of these features for another partition, you must enter the User Programming menu from a touchpad in that parti-

tion, or *jump* into that partition, then enter the User Programming menu.

## Jumping Partitions

The System Master is the only code that can jump partitions by default, but the ability to jump to another partition is an attribute that can be assigned to a user code. Refer to the User Sheets in Appendix A to see if any other access codes have the ability to jump partitions.

An alternative to jumping partitions is to arm, disarm, or program from a hardwire touchpad belonging to the other partition.

### To jump partitions:

1. From any hardwired touchpad, press  $\boxed{8} + \text{user code} + \boxed{0}$ .  
Alphanumeric touchpads display, “ENTER PARTITION.”
2. Press  $\boxed{1}$  if you want to change to Partition 1 or  $\boxed{2}$  if you want to change to Partition 2.  
The touchpad sounds one short beep if the jump was successful. One long beep means the jump was not successful. Alphanumeric touchpads display the text in the newly entered partition.
3. Proceed to arm, disarm, or program as needed. The partition assignment reverts back if no keys are entered for 10 seconds.

### Arming and Disarming the Other Partition

Once in the other partition, you need to use a code that is valid in that partition to arm, disarm or program that partition.

### Programming the Other Partition

Only one partition can be programmed at a time. When one partition is using the programming menu, touchpads in the other partition are locked out from any programming activity. Arming and disarming can continue, however.

Some partition-specific settings share resources, such as access codes and time schedules. For example, if Partition 1 uses Regular User numbers 00 through 20, Partition 2 will not be able to see or use those user numbers. The first Regular User number available to Partition 2 would be 21.

The allocation of time schedules works in much the same manner. There are 16 schedules that can be used by either partition, but as soon as Partition 1 attaches a schedule to any event, that schedule cannot be used by Partition 2, and vice versa.

## USING THE PANEL DOWNLOAD FEATURE

Your security system dealer may be able to update the information in the memory of your panel over the phone lines. This process is called *downloading*. Downloading is performed only by your dealer using software specifically designed for this panel.

Turning the Download feature on allows the dealer telephone access to your panel in order to perform the following maintenance procedures:

- Update your account.
- Back up data from your panel.
- Allow your dealer to quickly implement requested programming changes.

**Note:** Before allowing any download sessions, the system must be disarmed to level 1-OFF (DISARMED).

**To enable (or disable) the Panel Download setting:**

1. Enter the programming menus by pressing **[9]** + *System or Partition Master Code*.
2. Press **[4]** + **[1]**.
3. To turn Downloading on, press **[2]** + **[#]**. The dealer will be able to program your system by phone if necessary. To turn Downloading off, press **[1]** + **[#]**. The dealer will not be able to program your system by phone.
4. Press **[\*]** + **[6]** + **[#]** to exit the programming menus.

## SYSTEM INFORMATION

It may be useful for you to know the factory code, the system number, and the system level of your security system.

**To identify system information:**

1. Enter the programming menus by pressing **[9]** + *System or Partition Master Code*, then use step 2 to access the Factory Code OR use step 3 to access the System Number OR use step 4 to access the System Level.
2. Press **[\*]** + **[5]** + **[0]** and the touchpad displays "FACTORY CODE *nnnnnnn*." Press **[A]** or **[B]** to scroll to System Number and System Level.
3. Press **[\*]** + **[5]** + **[1]** to display the system number. For example, "SYSTEM NUMBER *nnnnnnn*." Press **[A]** or **[B]** to scroll to System Level and Factory Code.
4. Press **[\*]** + **[5]** + **[2]** to display the system level. For example, "SYSTEM LEVEL *nnnn*." Press **[A]** or **[B]** to scroll to System Number and Factory Code.
5. After identifying the information for your system, make a note of it in the Appendix A User Sheets.
6. Press **[\*]** + **[6]** + **[#]** to exit the programming menus.

## USING A TOUCH TONE (OR DTMF) PHONE TO OPERATE YOUR SYSTEM



Your system may be equipped with a phone module that allows system operation from a Touch Tone (or DTMF) phone on or off the premises.

The module contains a digital-voice chip, enabling programmed text to be spoken through the phone and/or broadcast through interior speakers. Except for custom words, the voice will speak the text that appears on alphanumeric touchpads in the system. The volume of the voice can be adjusted from the user programming Options menu (see Appendix C).

## Phone Command Prefix

What distinguishes a call to the panel from any other out-going or incoming call is the use of the Phone Command Prefix.

- In the case of on-site operation, if the Phone Command Prefix is dialed first, the panel waits for a valid access code or command.

- If the system is being accessed remotely, the Phone Command Prefix is used in conjunction with the access code.

The prefix is usually #, but can be changed to \* by the installer. If your prefix has been changed, use \* as the first key you press instead of # in the following instructions.

## Accessing the System from Off-site

To access the system from off-site, the system needs to recognize two things about the call:

- The panel needs to recognize that it should answer the phone.
- The panel needs to recognize that the code entered has the authority to operate the system from off-site.

When using a cellular phone to operate the system, follow the off-site operating directions.

### *How the Panel Answers the Phone*

When you call the panel, it needs to recognize that it should answer the incoming call. This is accomplished by one of three methods:

- 2Ring-Hang-2Ring method
- Twelve-Ring method
- Toll Saver

**2Ring-Hang-2Ring Method.** You can use this method if there is no chance that an answering machine or person will pick up the call on the first ring.

1. Call the panel. (In most cases this is the same number as the regular phone.)
2. Let the phone ring twice, then hang up.
3. Wait between 8 and 30 seconds, then call the panel again. This time the panel will answer ("System hello,") on the second or third ring.
4. Enter # (your designated Phone Command Prefix).
5. Enter your access code.
6. You hear a short status message, such as "System is OK."
7. Proceed with system commands.

**Twelve-Ring.** You can use this method if there is no chance that an answering machine or person will pick up the call before the twelfth ring.

1. Call the panel and let the phone ring. The panel will answer "System hello," after the twelfth ring.
2. Enter # (your designated Phone Command Prefix).
3. Enter your access code.
4. You hear a short status message, such as, "System is OK."

5. Proceed with system commands.

**Toll Saver.** You can use this method if you plan to call long distance to check the status of your system and there is no chance that an answering machine or person will pick up the phone before the eighth ring. When Toll Saver is programmed on, the panel will answer on the eighth ring if there is anything to report. If the panel has nothing to report to you, it will wait until the twelfth ring to answer.

With Toll Saver on, you will know that all is well if the panel hasn't answered after 8 rings. This gives you the option to hang up before the panel answers, thus saving yourself the cost of a long-distance toll.

### Codes with Remote Access Capability

The ability to access the system from off-site is a code attribute given by the installer, and you can have access code privileges changed by contacting the installer.

The System Master and Partition Master codes have Remote Access capability by default. Check the User Sheets in Appendix A to see which user codes have the ability to operate the system from off-site.

## Touch Tone (or DTMF) Phone System Operation

Phone operation of your system involves 2 steps:

### 1. Use a Touch Tone (or DTMF) phone to access the system.

<b>Local Phone Access</b>	Pick up the phone. Within 5 seconds of picking up the phone receiver, enter the command (see the command list in step 2).
<b>Remote Phone Access</b>	Use the 2Ring-Hang-2Ring or the Twelve-Ring method to get the system to answer the call. Then enter $\# + code$

### 2. Enter the command.

Disarm the system	$\# + 1 + code$
Arm to Level 2	$\# + 2 + code$
Arm to Level 3	$\# + 3 + code$
Send a Police panic alarm *	$* + * + * + * + * + *$ (Available from on-site only.)
Arm system with No Delay	$\# + 2 + code + 4$ or $\# + 3 + code + 4$
Arm system with exit lights off	$\# + 2 + code + 0$ or $\# + 3 + code + 0$
Bypass a sensor	Indirectly: Arm system + $\# + \# + code$ Directly: $\# + \# + code + Sensor Number$

### 2. Enter the command. (Continued)

Arm silently	$\# + 5 + 2 + code$ or $\# + 5 + 3 + code$
Turn all lights on/off	$\# + 0 + 0$
Turn specific lights on/off	$\# + 0 + Light number$
Turn Output on/off	$\# + 7 + 7 + Output number$
Cancel an accidental alarm	$\# + 1 + code$
Check the system status	$\# + *$
Turn Chime on/off	$\# + 7 + 1$
Disable local phone access	$\# + 7 + 3$ (available only from a phone on the premises)
Check alarm memory	$\# + 7 + 6$

\* If your partition is set up to send a Police panic alarm, use the  $*$  key regardless of your phone command key. Do not wait more than two seconds between keystrokes. Continue pressing  $*$  even if you hear the system voice interrupt with a system status. Police panic alarms can be only be activated from a Touch Tone (or DTMF) phone in the partition. The alarm cannot be activated from a phone off-site.

### Frequently Asked Questions

#### What if someone calls while I'm operating the panel?

If the phone rings while you're using it to operate the system, you'll hear one long beep for each ring from interior speakers and phones. You can answer the call by simply hanging up on the system, then answering the call as you normally would.

You'll have to initiate another session to resume operation.

#### Can I control the system while I'm talking on the phone?

No. You must press  $\#$  within 5 seconds after you pick up the phone, and the phone must be on the premises.

#### To control the system while on the phone:

- $\# + Command$

#### How do I perform other phone operations without commanding my security system?

You can use your phone for transactions such as banking from home by temporarily disengaging phone control to your security system. The command described below works for one call at a time.

#### To disengage local phone control:

Enter  $\# + 7 + 3$ .

The system responds by returning a dial tone.

## TESTING THE SYSTEM

The system contains a test mode that allows you to test sensors and panic signals without creating false alarms. Test your system weekly by following the instructions in this section carefully.

### Automatic Test Features

Your security system conducts routine tests, checking for problems like power failures, low batteries, sensors that aren't working, and communication trouble with the central monitoring station.

When your system detects a problem, trouble beeps sound to alert you. See "Troubleshooting" on page 19 for an explanation of the causes of trouble beeps and what you can do to fix the problem.

### Manual Tests

The automatic tests your system performs provide continuing reassurance that it is working properly. There are also weekly system tests you can do yourself as an added safeguard. Taking time to do these tests will familiarize you with your system and alert you to anything unusual, such as cut phone lines or sensors that have been tampered with.

#### Sensor Test

This test verifies that the sensors in your system are operating correctly. To conduct a sensor test, press **[\*]** + code + **[\*]**.

The ability to conduct a sensor test is a code attribute given per User code. Check the Appendix A User Sheets to see which access codes have the ability to conduct a sensor test.

**Table 1. Device Specific Sensor Test Procedures**

Device	Test procedure	Touchpad Display*
Touchpads	Send a: <ul style="list-style-type: none"> <li>• Police panic alarm</li> <li>• Fire panic alarm</li> <li>• Auxiliary panic alarm.</li> </ul>	<ul style="list-style-type: none"> <li>• POLICE PANIC OK</li> <li>• FIRE PANIC OK</li> <li>• AUXILIARY PANIC OK</li> </ul>
Wireless Touchpads	Press the Bypass key.	• TOUCHPAD <i>nn</i> OK
Keychain Touchpads	Press and hold the two assigned panic buttons simultaneously for 3 seconds.	<ul style="list-style-type: none"> <li>• POLICE PANIC OK</li> <li>• AUXILIARY PANIC OK</li> </ul>
Panic buttons	Press and hold the appropriate panic button(s) for 3 full seconds.	• SENSOR <i>nn</i> OK
Door/window sensor	Open the secured door or window.	• SENSOR <i>nn</i> OK
Smoke detector	Press and hold the test button until the system sounds transmission beeps.	• SENSOR <i>nn</i> OK
Motion detector	Avoid the motion detector view for 5 minutes, then enter its view.	• SENSOR <i>nn</i> OK
Rate-of-Rise Heat Detector	Rub your hands together until warm, then place one hand on the detector for 30 seconds.	• SENSOR <i>nn</i> OK
Shock sensor	Tap the glass twice, away from the sensor. Wait at least 30 seconds before testing again.	• SENSOR <i>nn</i> OK
Glass guard sensor	Tap the glass 3 or 4 inches from the sensor.	• SENSOR <i>nn</i> OK
<ul style="list-style-type: none"> <li>• If you need more time to complete testing, restart the timer by pressing <b>[*]</b> + Code + <b>[*]</b>.</li> <li>• Check to see that all sensors have been tested by pressing <b>[*]</b>. Touchpads display a list of untested sensors.</li> <li>• You will know that you have finished testing when touchpads display, "SENSOR TEST OK."</li> </ul>		
<b>3. Disarm to Level 1 to exit Test Mode. (See "Arming Your System" on page 5.)</b>		

\* If sensor text was programmed, it will be included in the sensor test display.

#### Phone Communication Test

After the test has started, the arming level can be changed to Level 1—Disarm, then to Level 2—HOME or Level 3—AWAY, as desired.

##### To perform a phone communication test:

1. Contact the central monitoring station to inform them that you want to test the phone communication of your system.
2. Disarm the system.
3. Press **[\*]** + System or Partition Master Code + **[\*]**. The touchpad displays "PHONE TEST."

##### On alphanumeric touchpads:

- If the phone test is successful, the touchpad display returns to a normal text display.
- If the phone test is *unsuccessful*, the touchpad displays "SYSTEM PHONE TEST ALARM," then, "MEMORY," and finally (after eight failed attempts), "PHONE FAILURE ALARM MEMORY."

### Testing Sirens

The purpose of this weekly test is to verify that the panel is activating sirens with the appropriate warning sounds.

#### To perform an alarm siren warning sound test:

1. Contact the central monitoring station to inform them that you will be activating alarms and **they should not dispatch authorities**.
2. Activate alarms of each type (fire, police, auxiliary), one at a time.
3. Listen for the appropriate siren sound when each alarm is activated (see “System Alarm Sounds” on page 10).
4. Contact the central monitoring station to inform them that you are finished activating alarms.

## TROUBLESHOOTING

Your security system uses a variety of different alarm sirens, status beeps, and trouble beeps to communicate with you. The next few pages describe the different sounds and what they mean. Try to familiarize yourself with the differences. You will hear some sounds each time you tell your security system to do something like arm or disarm. Some sounds you will hear only when there is a problem with the system, like a low battery. Other sounds you will only hear in an emergency. Getting to know your system sounds allows you to react quickly and appropriately.

### Trouble Beeps and Trouble Messages

Trouble beeps are a series of five short beeps, once a minute. When your system detects a problem, it lets you know by sounding trouble beeps from touchpads and sirens and by trouble messages on touchpad displays.

Table 2 on page 19 lists the causes of trouble beeps, the visual display you can expect to see, and possible solutions for the trouble condition.

#### Silencing Trouble Beeps

If possible, correct the situation that is causing the trouble beeps. If this is not possible, call for service. If the problem is not corrected, trouble beeps and messages start again 4 to 10 hours later.

#### To stop trouble beeps:



- Perform a system status check by pressing  on a touchpad.
- Change the arming level.

Table 2 describes the conditions under which trouble beeps occur. (These sounds are heard from interior sirens and touchpads if available.)

### Common Concerns

#### “I can’t arm my system.”

Try the following:

- If arming to Level 2—HOME or Level 3—AWAY, make sure all monitored perimeter doors and windows are closed.
- Press  for a system status and for clues to the problem.
- Call the installer.

#### “I cannot bypass a sensor: my alphanumeric touchpad displays INVALID.”

Possible explanations include:

- The sensor you’re trying to bypass may not be active in the current arming level. For example, an interior motion detector will not be active in Level 2—HOME.
- Some sensors can be bypassed only in certain levels. For example, motion sensors in Level 3—AWAY.
- You may be trying to bypass a 24-hour sensor that cannot be bypassed, such as a smoke detector.

#### “I can’t arm my system to Level 3—AWAY.”

If you arm the system to Level 3 but do not exit through a delay door, the system may arm to Level 2 instead. Arm the system to Level 3, then exit through a delay door.

### Checking the Panel Fuse

The fuse is located in the main 220 VAC power connector within the panel. If you suspect that the panel fuse may need replacement, do not attempt to change the fuse yourself. Contact your dealer and arrange to have a qualified engineer service your panel.

**Table 2. Causes of Trouble Beeps**

Touchpad Feedback After Pressing 	Trouble Condition
AC POWER FAILURE	There may be an AC power outage. Check the circuit breaker or fuse that controls power to the panel. Have a qualified person check the panel fuse. The backup battery will take over, but if AC power is not restored within 15 minutes, the system will alert you and the central monitoring station (if your system is monitored). It reports again when power is restored.
SYSTEM LOW BATTERY TROUBLE	The power in the emergency backup battery is low and must be recharged or replaced. If AC power is out, the security system may shut down once the battery is below the operating level. When AC power is restored, the panel will recharge the battery. If the trouble condition exists more than 24 hours after AC power is restored, call your security dealer for service.

**Table 2. Causes of Trouble Beeps**

<b>Touchpad Feedback After Pressing </b>	<b>Trouble Condition</b>
SENSOR SUPERVISORY	<p>There is a problem with how the sensor is communicating with the panel.</p> <ol style="list-style-type: none"> <li>1. Test the sensor in Test Mode as described in Table 1 on page 18.</li> <li>2. If the sensor does not test OK, call your security dealer for service.</li> </ol> <p>If Immediate Beeps is on with the system armed, sensor supervisory conditions activate a Tamper Alarm instead of Trouble Beeps.</p>
SENSOR TROUBLE	<p>A sensor may have an internal problem or a fire/smoke sensor may not have properly reset after activation, or the sensing chamber may be dirty or partially obstructed.</p> <ol style="list-style-type: none"> <li>1. Test the sensor in Test Mode as described in Table 1 on page 18.</li> <li>2. If testing the sensor does not clear the trouble condition, call your security dealer for service.</li> </ol>
SENSOR XX LOW BATTERY	<p>A sensor has a low battery.</p> <ol style="list-style-type: none"> <li>1. Disarm the system.</li> <li>2. Remove the sensor cover. If the battery is an Alkaline AAA, change the battery. If the battery is any other type, call your security dealer for service.</li> </ol>
SENSOR XX TAMPER	<p>A sensor cover is off or open. Secure the cover and trip the sensor to clear the tamper condition.</p>
PHONE FAILURE TROUBLE	<p>The system can't communicate with the central monitoring station. The system tries to report to the central station three times before indicating Phone Failure Trouble, then makes five more reporting attempts.</p> <ol style="list-style-type: none"> <li>1. Make sure the panel is connected to the special phone jack installed by your security dealer.</li> <li>2. Disconnect the panel from the special phone jack and check phones for dial tone. <ul style="list-style-type: none"> <li>If you hear a dial tone, call your security dealer for service.</li> <li>If you don't hear a dial tone from any phones, telephone service in your area may be out.</li> </ul> </li> </ol> <p>Phone Failure Trouble takes precedence over other system problems, so you must clear the Phone Failure message (by disarming the panel) before you're able to see other system messages.</p>
RECEIVER INTERFERENCE or RECEIVER FAILURE	<p>There is a receiver failure or receiver interference problem. Call your security dealer for service.</p>
MEMORY FAILURE	<p>There is a system memory failure. Call your security dealer for service.</p>
BUS TAMPER	<p>The cover tamper was tripped on a sensor or other system devices. Secure the cover of the device that is reporting a tamper or contact you dealer for service.</p>

# APPENDIX A: USER SHEETS

These User Sheets, which contain specific information about the setup of your system, should be completed by the installer and you.

## ACCOUNT NUMBER

My central station account number is

\_\_\_\_\_

## SYSTEM SENSORS

Record the sensor number, partition, and name in the table below. Indicate whether it is a hardwired sensor (HW), wireless sensor (WL), or touchpad (TP).

No.	Ptn.	Sensor Name	HW / WL / TP
01			
02			
03			
04			
05			
06			
07			
08			
09			
10			
11			
12			
13			
14			
15			
16			
17			
18			
19			
20			
21			
22			
23			
24			
25			
26			
27			

No.	Ptn.	Sensor Name	HW / WL / TP
28			
29			
30			
31			
32			
33			
34			
35			
36			
37			
38			
39			
40			
41			
42			
43			
44			
45			
46			
47			
48			
49			
50			
51			
52			
53			
54			
55			
56			
57			
58			
59			
60			
61			
62			
63			
64			
65			

No.	Ptn.	Sensor Name	HW / WL / TP
66			
67			
68			
69			
70			
71			
72			
73			
74			
75			
76			
77			
78			
79			
80			
81			
82			
83			
84			
85			
86			
87			
88			
89			
90			
91			
92			
93			
94			
95			
96			

## USER CODES

The tables below provide space for you to record user codes and the attributes of each.

**B** (Bypass)

User can bypass sensors.

**RA** (Remote Access)

User can access the system from a phone

**PJ** (Partition Jump)

User can access both partitions

**S** (System Tests)

User can perform system tests.

Defaults are indicated by ✓

User	B	RA	PJ	S	Code
System Master	✓	✓	✓	✓	(Default: 12345)
Partition Master	✓	✓		✓	(Default: none)
00					
01					
02					
03					
04					
05					
06					
07					
08					
09					
10					
11					
12					
13					
14					
15					
16					
17					
18					
19					
20					
21					
22					
23					



User	B	RA	PJ	S	Code
24					
25					
26					
27					
28					
29					
30					
31					
32					
33					
34					
35					
36					
37					
38					
39					
40					
41					
42					

## OUTPUT CONTROL

Use the table below to record the output numbers programmed for user control. Outputs that are programmed for user control can be activated or deactivated from any touchpad by pressing  $\square + \square + \text{output number}$ .

**Table 3. Outputs Controlled by User**

Output number	Partition	Output Description
1		
2		
3		
4		
5		
6		

## LIGHTS

The housecode for the X-10 modules is:

Partition 1: \_\_\_\_\_

Partition 2: \_\_\_\_\_

Record the location of each light.

Light	Parti-tion	Location of Light
1	1 / 2	
2	1 / 2	
3	1 / 2	
4	1 / 2	
5	1 / 2	
6	1 / 2	
7	1 / 2	
8	1 / 2	
9	1 / 2	

## TOUCHPAD INFORMATION

Status beeps and Key beeps are programmed by the installer.

The Silent Arming feature is programmed by the user.

**Note:** Protest beeps will always sound when indirectly bypassing a sensor.

Location of TP	Status Beeps	Key Beeps
	On/Off	On/Off
	On/Off	On/Off
	On/Off	On/Off
	On/Off	On/Off
	On/Off	On/Off
	On/Off	On/Off
	On/Off	On/Off
	On/Off	On/Off
	On/Off	On/Off
	On/Off	On/Off

*Is the Touchpad Tamper feature on?*

- Yes. If, when the system asks for a code, more than 40 touchpad keys are pressed in rapid succession and those keystrokes are not part of a valid access code, a siren will sound.
- No. Multiple keystrokes that are not part of a valid access code will not send an alarm.

There are \_\_\_\_\_ keychain touchpads in use in the system.

**Keychain Touchpad 1**

Press the Lock key to

- Increase the arming level.
- Arm the system to Level 3 with no Exit or Entry delay.

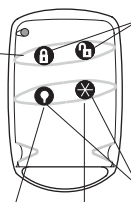

Press both at one time to

- Create a Police panic alarm.
- Create an Auxiliary panic alarm.
- Other: \_\_\_\_\_

Press both at one time to create an Auxiliary panic alarm

Press the Star key to \_\_\_\_\_

Press the Light key to turn all system lights off or on. \_\_\_\_\_

**Keychain Touchpad 2**

Press the Lock key to

- Increase the arming level.
- Arm the system to Level 3 with no Exit or Entry delay.

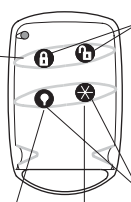

Press both at one time to

- Create a Police panic alarm.
- Create an Auxiliary panic alarm.
- Other: \_\_\_\_\_

Press both at one time to create an Auxiliary panic alarm

Press the Star key to \_\_\_\_\_

Press the Light key to turn all system lights off or on. \_\_\_\_\_

**Keychain Touchpad 3**

Press the Lock key to

- Increase the arming level.
- Arm the system to Level 3 with no Exit or Entry delay.

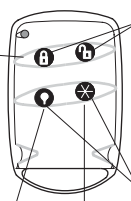

Press both at one time to

- Create a Police panic alarm.
- Create an Auxiliary panic alarm.
- Other: \_\_\_\_\_

Press both at one time to create an Auxiliary panic alarm

Press the Star key to \_\_\_\_\_

Press the Light key to turn all system lights off or on. \_\_\_\_\_

**Keychain Touchpad 4**

Press the Lock key to

- Increase the arming level.
- Arm the system to Level 3 with no Exit or Entry delay.

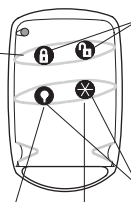

Press both at one time to

- Create a Police panic alarm.
- Create an Auxiliary panic alarm.
- Other: \_\_\_\_\_

Press both at one time to create an Auxiliary panic alarm

Press the Star key to \_\_\_\_\_

Press the Light key to turn all system lights off or on. \_\_\_\_\_

**ACCIDENTAL SMOKE AND FIRE ALARMS**

To silence the alarms and reset the sensor:

1. Press **[1]** + Code once to silence the alarm.
2. Press **[1]** + Code again to reset the smoke alarm.

**Note:** In partitioned systems with the Global Fire feature enabled, the above procedure must be performed in each partition.

*Smoke and fire panic alarms cannot be cancelled and are always reported to the central station.*

If, after disarming the system once, the system still thinks a sensor is open, disarm the system again.

In the event of an accidental smoke or fire alarm, follow these dealer instructions:

---

---

---

---

---

---

---

---

---

---

**DIALER ABORT**

*Is the Dialer Abort feature enabled?*

- Yes. I have \_\_\_\_\_ seconds to cancel an accidental intrusion or auxiliary alarm before it is reported to the central station.
- No. All alarms are reported to the central station immediately.

## ARMING INFORMATION

### Delay Doors and Delay Time Settings

When the system is armed, enter and exit the premises only through designated delay doors.

The time allowed to enter the premises and disarm the system is the Entry Delay time.

The time allowed to leave the premises after arming the system is the Exit Delay time.

Door	Door Location	Entry Delay	Exit Delay
1		:	:
2		:	:
3		:	:
4		:	:
5		:	:

Feature	My system features include
Quick Arm	<input type="checkbox"/> Yes. Press the arming level desired. <input type="checkbox"/> No. Enter arming level, then access code.
Quick Exit	<input type="checkbox"/> Yes. Press [0] and exit your armed premises through a delay door within 2 minutes. <input type="checkbox"/> No. I need to disarm my system in order to exit the premises.
Exit Extension	<input type="checkbox"/> Yes. If I re-enter the armed premises during the Exit Delay time, the Exit Extension will begin. <input type="checkbox"/> No. If I re-enter the armed premises during the Exit Delay time, it will continue to count down and I must disarm the system.
Keyswitch Arming	<input type="checkbox"/> Yes. I can use a key to arm the system. The switch is located: <hr/> <hr/> <input type="checkbox"/> No.
Auto HOME Arming	<input type="checkbox"/> Yes. If, after arming to Level 3—AWAY, I don't exit through a designated delay door, the system will arm to Level 2—HOME. <input type="checkbox"/> No. If, after arming to Level 3—AWAY, I don't exit through a designated delay door, the system will continue to arm to Level 3—AWAY. And, if my system contains motion detectors, movement may cause an alarm.

## REPORTING

For what events will the central station be notified?

Reporting Features	CS 1	CS 2	CS 3
High Level Reports*			
Low Level Reports*			
Opening/Closing Reports			
Exception Reports			

\*The following table lists the features that generate high and low level reports to the central station in column one. Column two and three indicate whether the event is considered a high level event or a low level event.

Event	High Level	Low Level
Sensor 01-96 Alarm	Ⓜ	
Sensor 01-96 Bypass		Ⓜ
Sensor 01-96 Low Battery		Ⓜ
Sensor 01-96 Tamper	Ⓜ	
Sensor 01-96 Supervisory		Ⓜ
Sensor 01-96 Restorals	Ⓜ	
Sensor 01-96 Trouble		Ⓜ
Phone Test	Ⓜ	
AC Power Fail		Ⓜ
CPU Low Battery		Ⓜ
Auto Phone Test		Ⓜ
Receiver Failure	Ⓜ	
Receiver Jam	Ⓜ	
CPU Back in Service		Ⓜ
Phone Failure		Ⓜ
Event Buffer Full		Ⓜ
Two Trip Error		Ⓜ
Main Unit Tamper	Ⓜ	
Antenna Tamper	Ⓜ	
System Tamper	Ⓜ	
Bus Supervisories	Ⓜ	
No Activity Alarm	Ⓜ	
Fire Panic	Ⓜ	
Police Panic	Ⓜ	
Auxiliary Panic	Ⓜ	
Duress Alarm	Ⓜ	
Force Arm		Ⓜ
Auto Force Arm		Ⓜ
Recent Closing		Ⓜ
Sensor Test Entry/Exit	Ⓜ	
Bus Device Tamper	Ⓜ	

## IF THE POWER GOES OUT

Your system has a backup battery that keeps your system operational during a power failure. An optional feature allows your system to alert the central monitoring station if the power is off for more than 15 minutes. It reports again when power has been restored.

## NO ACTIVITY TIME

*My system uses the No Activity feature.*

- Yes. If there is no activity in my system for \_\_\_\_ hours (1-42, default 24), the system will send a No Activity report to the Central Station.
- No. My system setup does not include this feature.

## SYSTEM INFORMATION

System Information	Code
Factory code	
System number	
System level	

## APPENDIX B: PLANNING FOR EMERGENCIES

Develop plans for a variety of emergency situations. Periodically discuss and rehearse emergency plans that include the following items:

- Understand how to use your security system.
- Know the normal state of doors and windows (open, closed, or locked).
- Use a different escape route if closed doors feel hot to the touch.
- Emphasize that everyone should escape as quickly as possible. Do not stop to gather any belongings.
- Crawl and hold your breath as much as possible to help reduce smoke inhalation during your escape.
- Meet at a designated outdoor location.
- Emphasize that no one should return to the premises if there is a fire.
- Notify fire department from a neighbor's phone.

**WARNING!** If you arrive at the premises and hear sirens, do not attempt to enter the building. Call for emergency assistance from a neighbor's phone.

### FLOOR PLAN EXAMPLE

The figure on this page is an example of a multilevel floor plan. Use it as a guide and draw your floor plan on the next page.

### YOUR FLOOR PLAN

Use the following guidelines when drawing your floor plan.

- Show all building levels.
- Show exits from each room (two exits per room are recommended).
- Show the location of all security system components.
- Show the locations of any fire extinguishers.

### Alarm System Limitations

Not even the most advanced alarm system can guarantee protection against burglary, fire, or environmental emergencies. All alarm systems are subject to possible compromise or failure-to-warn for a variety of reasons including

- If sirens are not placed within range of persons sleeping, or if they are placed behind doors or other obstacles or in remote areas of the premises.
- If intruders gain access through unprotected entry points or areas where sensors are bypassed.
- If intruders have the technical means of bypassing, jamming, or disconnecting any or all parts of the system.
- If power to sensors is disconnected or inadequate.
- If freeze, flood, or any environmental sensors are not located in areas where the specific condition can be detected.
- If smoke does not reach a smoke sensor. For example, smoke sensors cannot detect smoke in chimneys, walls, roofs, or smoke blocked by a closed door. Sensors may not detect smoke on building levels different from their installed location. Sensors may

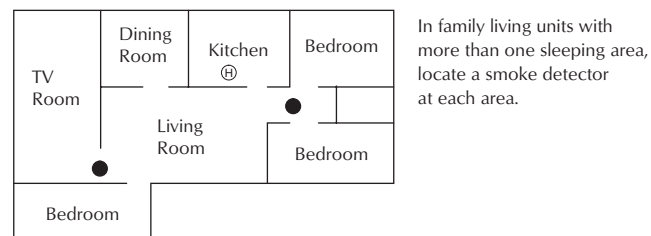
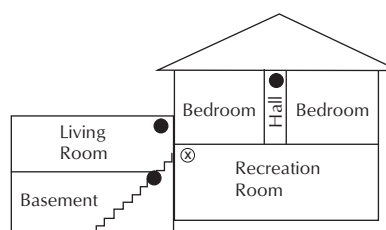
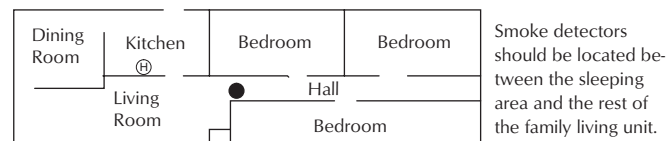
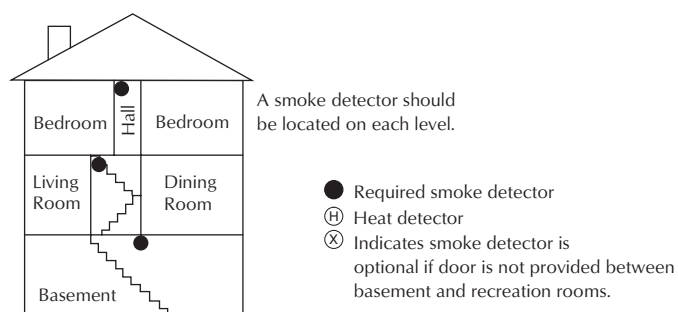

**NOTE:** Ceiling-mounted smoke detectors should be located in the center of the room or hall, or not less than 4 inches from the wall. When the detector is mounted on the wall, the top of the detector should be 4 to 12 inches from the ceiling.

**NOTE:** Do not install smoke detectors where normal ambient temperatures are above 100°F or below 40°F. Also, do not locate detectors in front of AC/Heat registers or other locations where normal air circulation will keep smoke from entering the detector.

not warn in time when fires are caused by smoking in bed, explosions, improper storage of flammables, overloaded electrical circuits, or other hazardous conditions.

- If telephone lines are out of service. Telephone lines are also vulnerable to compromise by any of several means.

Inadequate maintenance is the most common cause of alarm failure. Therefore, test your system once each week to verify sensors, sirens, and phone communications are all working correctly.

**Note:** Although having an alarm system can make you eligible for reduced insurance premiums, the system is no substitute for insurance.

**Warning:** Security systems and devices cannot compensate you for life or property losses.

### If Your System Needs Service

If you have any questions about your security system or if it ever needs servicing, please contact your security dealer.

Company Name \_\_\_\_\_

City \_\_\_\_\_ Country \_\_\_\_\_ Post Code \_\_\_\_\_

Phone Number (\_\_\_\_) \_\_\_\_\_

Contact Name \_\_\_\_\_

### **Floor Plan of Your Home or Business**

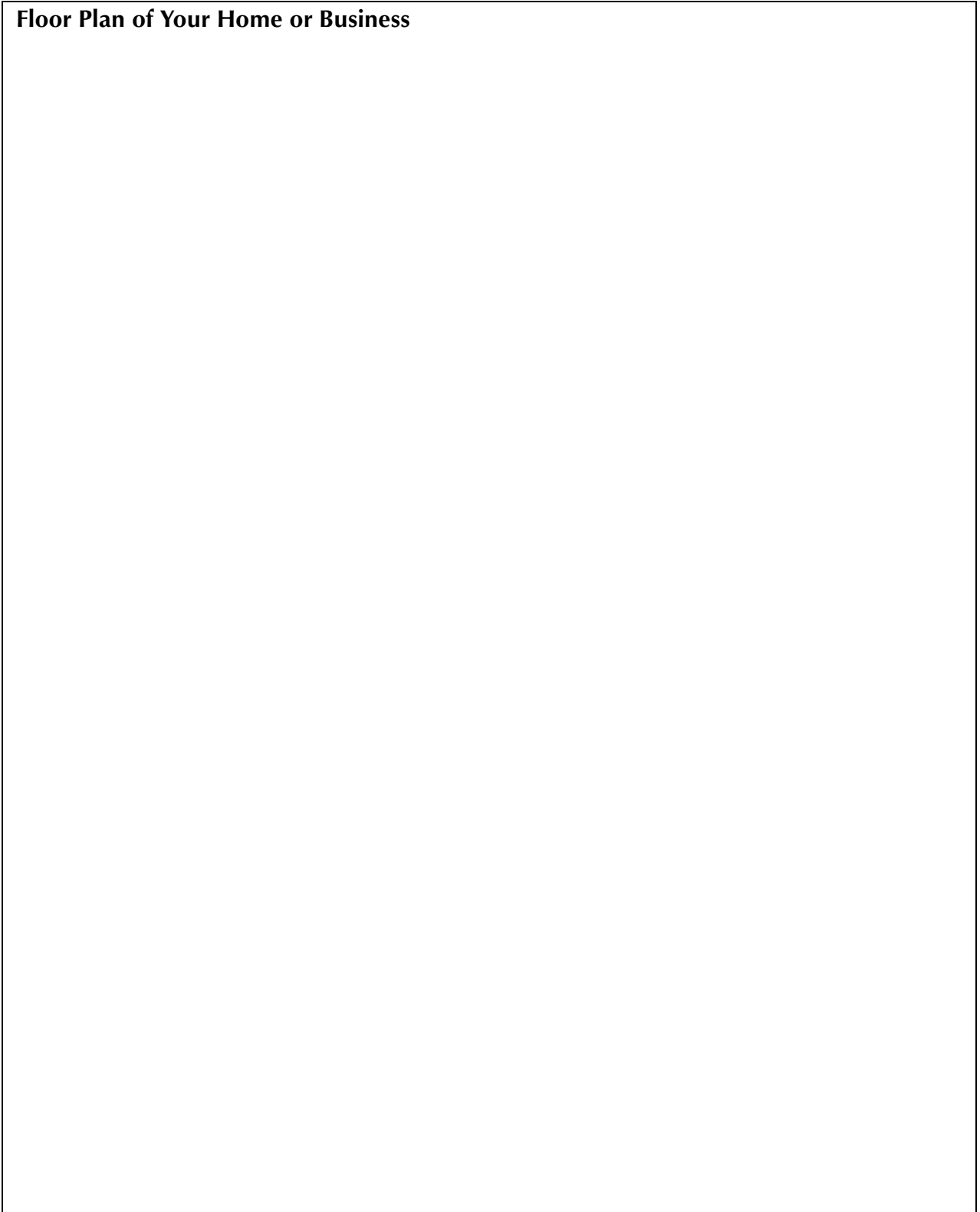
A large, empty rectangular box with a thin black border, intended for the user to draw a floor plan of their home or business. The box is currently blank.

## APPENDIX C: PROGRAMMING YOUR SYSTEM

You can program the following items on your system:

- System time and date
- User codes
- Downloading feature
- Silent Arming feature
- Brightness of touchpads
- Volume of system sounds
- Chime feature options
- Scheduling
- Installer Access

### TWO METHODS TO PROGRAM YOUR SYSTEM

There are 2 methods for programming your system:

- Programming menus—Offers visual text cues from your touchpad.
- Programming shortcuts—Allows you to type in a sequence of numbers for a specific programming task.

Either method requires a valid System or Partition Master code. You cannot program the system using a regular user code.

### Using Programming Menus

The programming menus are arranged much like a computer software program (menus containing multiple options).

To navigate through the menus:

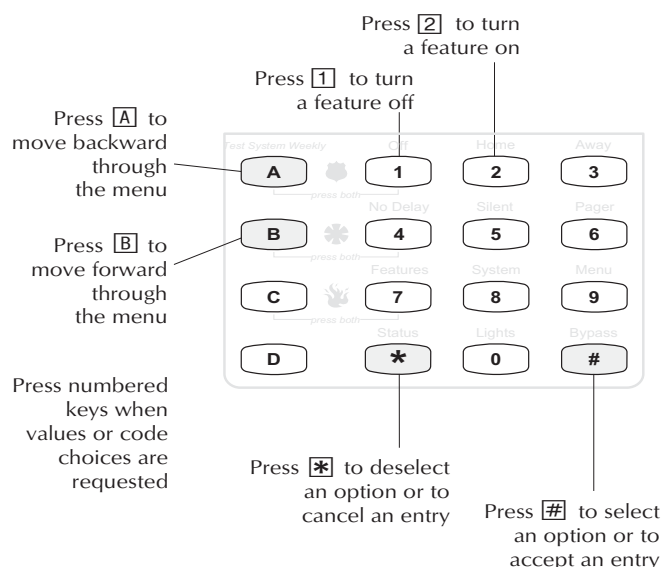

### Examples of Programming Using Menus

Here are two examples of programming using system menus. The examples describe each step involved in programming a user code and in erasing a user code.

#### To change or assign a user access code:

1. Enter the programming menus by pressing

**[9]** + System or Partition Master Code.

2. Press **[B]** until the touchpad displays “USER CODES,” then press **[#]**.
3. Press **[B]** until the touchpad displays the type of code you wish to change (Regular User codes or System or Partition Master Code), then press **[#]**.
4. Press **[B]** until the touchpad displays the user code you wish to change, then press **[#]**.
5. Enter the new code and press **[#]**.
6. Press **[B]**. “DIRECT BYPASSING” appears:
  - Press **[1]** + **[#]** to turn the option *off* for this user code.
  - Press **[2]** + **[#]** to turn the option *on* for this user code.
7. Press **[B]**. “REMOTE ACCESS” appears:
  - Press **[1]** + **[#]** to turn the option *off* for this user code.
  - Press **[2]** + **[#]** to turn the option *on* for this user code.
8. Press **[B]**. “PARTITION JUMP” appears:
  - Press **[1]** + **[#]** to turn the option *off* for this user code.
  - Press **[2]** + **[#]** to turn the option *on* for this user code.
9. Press **[B]**. “SYSTEM TESTS” appears:
  - Press **[1]** + **[#]** to turn the option *off* for this user code.
  - Press **[2]** + **[#]** to turn the option *on* for this user code.
10. Press **[\*]** + **[B]** to move to the next user code, or **[\*]** + **[6]** + **[#]** to exit the programming menus.

**Note:** The system will not accept the same code for two different users in the same partition.

#### To erase a user code:

1. Enter the programming menus by pressing **[9]** + System or Partition Master Code.
2. Press **[B]** until the touchpad displays “USER CODES,” then press **[#]**.
3. The touchpad displays “REGULAR USER CODES.” Press **[#]**. (You cannot erase the System Master Code.)
4. Press **[B]** until the touchpad displays the user code you wish to erase, then press **[#]**.  
For example, if you want to erase User code 4, press **[#]** when the touchpad displays “USER 04.”
5. Enter the System or Partition Master Code you used in Step 1 and press **[#]**. The erased code appears as “USER 04 — ,” for example.
6. Press **[\*]** + **[B]** to move to the next user code, or **[\*]** + **[6]** + **[#]** to exit the programming menus.

#### To change or delete the Partition Master Code:

1. Enter the programming menu by pressing **[9]** + System or Partition Master Code.
2. Press **[B]** until the touchpad displays “USER CODES,” then press **[#]**.
3. The touchpad displays “REGULAR USER CODES.” Press **[B]** until the display reads “PARTITION MASTER CODE,” then press **[#]**.
4. Enter the System Master Code to delete the existing Partition Master Code OR  
Enter a new 5-digit Partition Master Code to replace the existing code.
5. Press **[\*]** + **[6]** + **[#]** to exit the programming menus.

# Programming Menus:

To enter the Programming Menu, press  
**9** + System Master or Partition Master Code

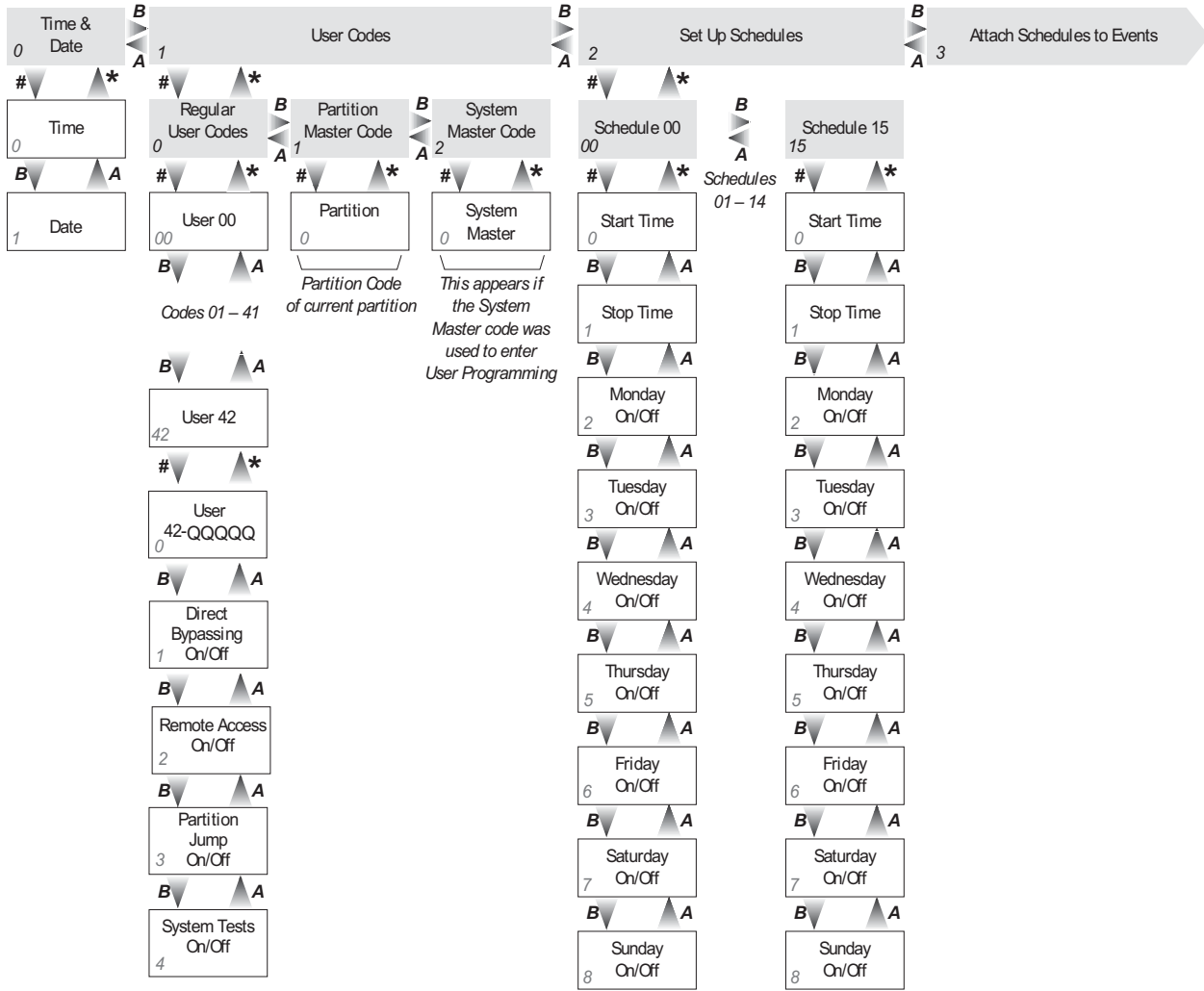



### Attach Schedules to Events

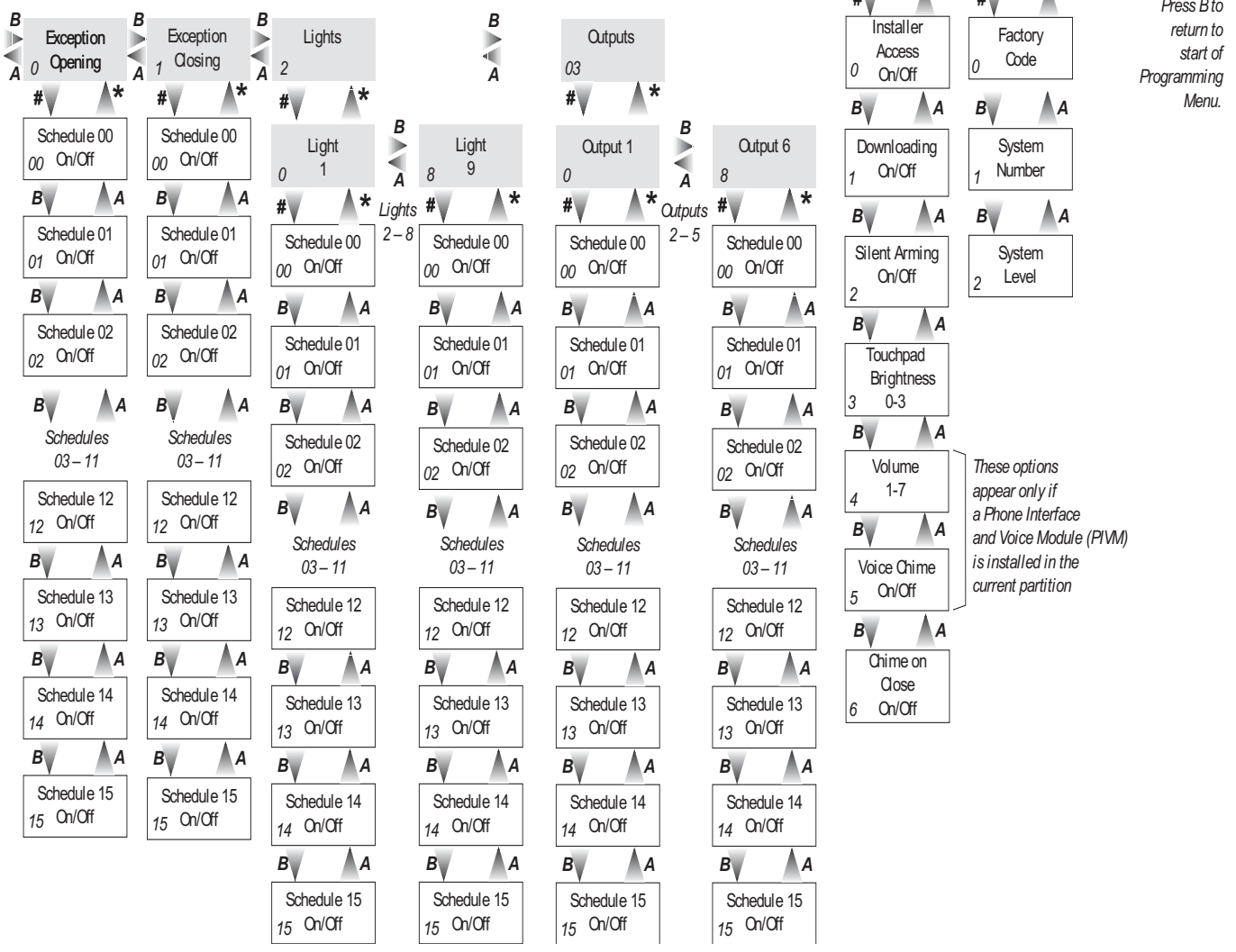

## Using Programming Shortcuts

A programming shortcut is a number that gets you to a particular spot in the programming menus. A series of shortcut numbers takes you directly to the feature or code you want to change.

### 1. Enter User Programming.

Local Phone	# + 9 + system or partition master code
Remote Phone Access	Dial the phone number + # + system or partition master code + # + 9 + system or partition master code
Alphanumeric Touchpad	9 + system master code

### 2. Enter a programming command sequence from Table 4.

**Table 4. Shortcut numbers**

Regular User Codes	<p>User 00: * + 1 0 0 0 0 0</p> <p>User 01: * + 1 0 0 0 1 0</p> <p>User 02: * + 1 0 0 0 2 0</p> <p>(Continues through User 42)</p> <p>User 42: * + 1 0 4 2 0 0</p> <p>After entering the shortcut, enter the new user code and press #.</p> <p>To use a shortcut number to access a user attribute, replace the last 0 with the shortcut number of the attribute (Direct Bypassing=1; Remote Access=2; Partition Jump=3; System Tests=4).</p> <p><b>Example:</b> The attribute shortcut numbers for User 42 would be</p> <p>Direct Bypassing * + 1 0 4 2 1</p> <p>Remote Access * + 1 0 4 2 2</p> <p>Partition Jump * + 1 0 4 2 3</p> <p>System Tests * + 1 0 4 2 4</p>
Partition Master Codes	* + 1 1 0 + the new partition code + #
System Master Code	* + 1 2 0 + the new System Master Code + #
Time	* + 0 0 + new time + #
Date	* + 0 1 + new date + #
Time Schedule 0	<p>Start Time: * + 2 0 0 0 + new Start Time + #</p> <p>Stop Time: * + 2 0 0 1 + new Stop Time + #</p> <p>Mon: * + 2 0 0 2 + 1 (off) or 2 (on) + #</p> <p>Tues: * + 2 0 0 3 + 1 (off) or 2 (on) + #</p> <p>Wed: * + 2 0 0 4 + 1 (off) or 2 (on) + #</p> <p>Thurs: * + 2 0 0 5 + 1 (off) or 2 (on) + #</p> <p>Fri: * + 2 0 0 6 + 1 (off) or 2 (on) + #</p> <p>Sat: * + 2 0 0 7 + 1 (off) or 2 (on) + #</p> <p>Sun: * + 2 0 0 8 + 1 (off) or 2 (on) + #</p>
Time Schedule 1	<p>Start Time: * + 2 0 1 0 + new Start Time + #</p> <p>Stop Time: * + 2 0 1 1 + new Stop Time + #</p> <p>Mon through Sun: * + 2 0 1 2 + 1 (off) or 2 (on) + #</p> <p>Sun: * + 2 0 1 8 + 1 (off) or 2 (on) + #</p>
Time Schedule 2	<p>Start Time: * + 2 0 2 0 + new Start Time + #</p> <p>Stop Time: * + 2 0 2 1 + new Stop Time + #</p> <p>Mon through Sun: * + 2 0 2 2 + 1 (off) or 2 (on) + #</p> <p>Sun: * + 2 0 2 8 + 1 (off) or 2 (on) + #</p>

Table 4. Shortcut numbers (Continued)

Time Schedule 3	<i>Start Time:</i> * + 2030 + <i>new Start Time</i> + # <i>Stop Time:</i> * + 2031 + <i>new Stop Time</i> + # <i>Mon:</i> * + 2032 + 1 (off) or 2 (on) + # <i>through</i> <i>Sun:</i> * + 2038 + 1 (off) or 2 (on) + #
Time Schedule 4	<i>Start Time:</i> * + 2040 + <i>new Start Time</i> + # <i>Stop Time:</i> * + 2041 + <i>new Stop Time</i> + # <i>Mon:</i> * + 2042 + 1 (off) or 2 (on) + # <i>through</i> <i>Sun:</i> * + 2048 + 1 (off) or 2 (on) + #
Time Schedule 5	<i>Start Time:</i> * + 2050 + <i>new Start Time</i> + # <i>Stop Time:</i> * + 2051 + <i>new Stop Time</i> + # <i>Mon:</i> * + 2052 + 1 (off) or 2 (on) + # <i>through</i> <i>Sun:</i> * + 2058 + 1 (off) or 2 (on) + #
Time Schedule 6	<i>Start Time:</i> * + 2060 + <i>new Start Time</i> + # <i>Stop Time:</i> * + 2061 + <i>new Stop Time</i> + # <i>Mon:</i> * + 2062 + 1 (off) or 2 (on) + # <i>through</i> <i>Sun:</i> * + 2068 + 1 (off) or 2 (on) + #
Time Schedule 7	<i>Start Time:</i> * + 2070 + <i>new Start Time</i> + # <i>Stop Time:</i> * + 2071 + <i>new Stop Time</i> + # <i>Mon:</i> * + 2072 + 1 (off) or 2 (on) + # <i>through</i> <i>Sun:</i> * + 2078 + 1 (off) or 2 (on) + #
Time Schedule 8	<i>Start Time:</i> * + 2080 + <i>new Start Time</i> + # <i>Stop Time:</i> * + 2081 + <i>new Stop Time</i> + # <i>Mon:</i> * + 2082 + 1 (off) or 2 (on) + # <i>through</i> <i>Sun:</i> * + 2088 + 1 (off) or 2 (on) + #
Time Schedule 9	<i>Start Time:</i> * + 2090 + <i>new Start Time</i> + # <i>Stop Time:</i> * + 2091 + <i>new Stop Time</i> + # <i>Mon:</i> * + 2092 + 1 (off) or 2 (on) + # <i>through</i> <i>Sun:</i> * + 2098 + 1 (off) or 2 (on) + #
Time Schedule 10	<i>Start Time:</i> * + 2100 + <i>new Start Time</i> + # <i>Stop Time:</i> * + 2101 + <i>new Stop Time</i> + # <i>Mon:</i> * + 2102 + 1 (off) or 2 (on) + # <i>through</i> <i>Sun:</i> * + 2108 + 1 (off) or 2 (on) + #
Time Schedule 11	<i>Start Time:</i> * + 2110 + <i>new Start Time</i> + # <i>Stop Time:</i> * + 2111 + <i>new Stop Time</i> + # <i>Mon:</i> * + 2112 + 1 (off) or 2 (on) + # <i>through</i> <i>Sun:</i> * + 2118 + 1 (off) or 2 (on) + #
Time Schedule 12	<i>Start Time:</i> * + 2120 + <i>new Start Time</i> + # <i>Stop Time:</i> * + 2121 + <i>new Stop Time</i> + # <i>Mon:</i> * + 2122 + 1 (off) or 2 (on) + # <i>through</i> <i>Sun:</i> * + 2128 + 1 (off) or 2 (on) + #
Time Schedule 13	<i>Start Time:</i> * + 2130 + <i>new Start Time</i> + # <i>Stop Time:</i> * + 2131 + <i>new Stop Time</i> + # <i>Mon:</i> * + 2132 + 1 (off) or 2 (on) + # <i>through</i> <i>Sun:</i> * + 2138 + 1 (off) or 2 (on) + #

**Table 4. Shortcut numbers (Continued)**

Time Schedule 14	<p>Start Time: * + 2140 + new Start Time + #</p> <p>Stop Time: * + 2141 + new Stop Time + #</p> <p>Mon: * + 2142 + 1 (off) or 2 (on) + #</p> <p>through</p> <p>Sun: * + 2148 + 1 (off) or 2 (on) + #</p>
Time Schedule 15	<p>Start Time: * + 2150 + new Start Time + #</p> <p>Stop Time: * + 2151 + new Stop Time + #</p> <p>Mon: * + 2152 + 1 (off) or 2 (on) + #</p> <p>through</p> <p>Sun: * + 2158 + 1 (off) or 2 (on) + #</p>
Exception Opening	<p>Attaching schedules for Exception Opening operation:</p> <p>Sched 0: * + 3000 + 1 (off) or 2 (on) + #</p> <p>Sched 1: * + 3001 + 1 (off) or 2 (on) + #</p> <p>(Continues through Schedule 15)</p> <p>Sched 15: * + 3015 + 1 (off) or 2 (on) + #</p>
Exception Closing	<p>Attaching schedules for Exception Closing operation:</p> <p>Sched 0: * + 3100 + 1 (off) or 2 (on) + #</p> <p>Sched 1: * + 3101 + 1 (off) or 2 (on) + #</p> <p>(Continues through Schedule 15)</p> <p>Sched 15: * + 3115 + 1 (off) or 2 (on) + #</p>
Light 1	<p>Attaching schedules for Light 1 operation:</p> <p>Sched 0: * + 32000 + 1 (off) or 2 (on) + #</p> <p>Sched 1: * + 32001 + 1 (off) or 2 (on) + #</p> <p>(Continues through Schedule 15)</p> <p>Sched 15: * + 32015 + 1 (off) or 2 (on) + #</p>
Light 2	<p>Attaching schedules for Light 2 operation:</p> <p>Sched 0: * + 32100 + 1 (off) or 2 (on) + #</p> <p>Sched 1: * + 32101 + 1 (off) or 2 (on) + #</p> <p>(Continues through Schedule 15)</p> <p>Sched 15: * + 32115 + 1 (off) or 2 (on) + #</p>
Light 3	<p>Attaching schedules for Light 3 operation:</p> <p>Sched 0: * + 32200 + 1 (off) or 2 (on) + #</p> <p>Sched 1: * + 32201 + 1 (off) or 2 (on) + #</p> <p>(Continues through Schedule 15)</p> <p>Sched 15: * + 32215 + 1 (off) or 2 (on) + #</p>
Light 4	<p>Attaching schedules for Light 4 operation:</p> <p>Sched 0: * + 32300 + 1 (off) or 2 (on) + #</p> <p>Sched 1: * + 32301 + 1 (off) or 2 (on) + #</p> <p>(Continues through Schedule 15)</p> <p>Sched 15: * + 32315 + 1 (off) or 2 (on) + #</p>
Light 5	<p>Attaching schedules for Light 5 operation:</p> <p>Sched 0: * + 32400 + 1 (off) or 2 (on) + #</p> <p>Sched 1: * + 32401 + 1 (off) or 2 (on) + #</p> <p>(Continues through Schedule 15)</p> <p>Sched 15: * + 32415 + 1 (off) or 2 (on) + #</p>
Light 6	<p>Attaching schedules for Light 6 operation:</p> <p>Sched 0: * + 32500 + 1 (off) or 2 (on) + #</p> <p>Sched 1: * + 32501 + 1 (off) or 2 (on) + #</p> <p>(Continues through Schedule 15)</p> <p>Sched 15: * + 32515 + 1 (off) or 2 (on) + #</p>
Light 7	<p>Attaching schedules for Light 7 operation:</p> <p>Sched 0: * + 32600 + 1 (off) or 2 (on) + #</p> <p>Sched 1: * + 32601 + 1 (off) or 2 (on) + #</p> <p>(Continues through Schedule 15)</p> <p>Sched 15: * + 32615 + 1 (off) or 2 (on) + #</p>

**Table 4. Shortcut numbers (Continued)**

Light 8	<p>Attaching schedules for Light 8 operation:</p> <p>Sched 0: * + 3 2 7 0 0 + 1 (off) or 2 (on) + #</p> <p>Sched 1: * + 3 2 7 0 1 + 1 (off) or 2 (on) + #</p> <p>(Continues through Schedule 15)</p> <p>Sched 15: * + 3 2 7 1 5 + 1 (off) or 2 (on) + #</p>
Light 9	<p>Attaching schedules for Light 9 operation:</p> <p>Sched 0: * + 3 2 8 0 0 + 1 (off) or 2 (on) + #</p> <p>Sched 1: * + 3 2 8 0 1 + 1 (off) or 2 (on) + #</p> <p>(Continues through Schedule 15)</p> <p>Sched 15: * + 3 2 8 1 5 + 1 (off) or 2 (on) + #</p>
Installer Access	* + 4 0 + 1 (off) or 2 (on) + #
Downloading	* + 4 1 + 1 (off) or 2 (on) + #
Silent Arming	* + 4 2 + 1 (off) or 2 (on) + #
Touchpad Brightness	* + 4 3 + N + # (enter 0 through 3)
Volume	* + 4 4 + N + # (enter 0 through 7)
Voice Chime	* + 4 5 + 1 (off) or 2 (on) + #
Chime on Close	* + 4 6 + 1 (off) or 2 (on) + #
Factory Code	* + 5 0
System Number	* + 5 1
System Level	* + 5 2
Exit	* + 6 + #

**Notes:**

## NOTICES

### Declaration of Conformity

**Manufacturer's Name:** GE Interlogix, Inc.

**Manufacturer's Address:** 2266 North 2nd Street  
North St. Paul, MN, USA  
55109

**EU Representative:** GE Interlogix Europe & Africa  
Excelsiorlaan 28  
B-1930 Zaventem  
Belgium



#### Product Identification

**Product:** PhoneWatch Security Panels

**Model Numbers:**  
60-840-43-24Z, 60-840-43-48Z,  
60-840-43-MAX,  
60-857-43-24Z, 60-857-43-48Z  
60-857-43-24Z-HS, 60-857-43-48Z-HS  
60-868-43-MAX, 60-868-43-48Z-HS

**Brand:** GE Interlogix

#### R&TTE Directive

See EMC and LVD tests below

#### EMC Directive

##### TUV Product Services

**Reports: N9601, N9601.1, and N9578**

EN 50130-4 (1995)  
EN 61000-3-2 (1995)  
EN 61000-3-3 (1995)  
EN 50065-1 (1991)  
ETS 300-683 (1997)

#### LVD Directive

##### GE Interlogix, Inc.

**Report:** 60-840-43 Safety Rev. B  
60-857-43 Safety Rev. A  
60-868-43 Safety Rev. A

EN 60950: 1994-4 3rd Edition

#### Means of Conformity

We declare under our sole responsibility that this product is in conformity with Directive 1999/5/EC (R&TTE); Directive 73/23/EEC (LVD); and Directive 89/336/EEC (EMC) and based on test results using (non)-harmonized standards in accordance with the Directives mentioned.

**Additional Tests.** This equipment has been tested and found to comply with the following standards (which are no longer required for compliance).

### Network Compatibility Declaration

We declare under our sole responsibility that this product is designed to work with the networks in the countries marked with a check (✓) and may have networking problems with the countries that are not checked.

Due to the inherent differences in the individual PSTNs, certain software settings may need to be adjusted on a country to country basis. If it is desired to use this equipment on a network other than

the one on which it was originally installed, you should contact your equipment supplier.

<input type="checkbox"/> Austria	<input type="checkbox"/> Liechtenstein
<input type="checkbox"/> Belgium	<input type="checkbox"/> Luxembourg
<input type="checkbox"/> Denmark	<input type="checkbox"/> Netherlands
<input type="checkbox"/> Finland	<input type="checkbox"/> Norway
<input type="checkbox"/> France	<input type="checkbox"/> Poland
<input type="checkbox"/> Germany	<input type="checkbox"/> Portugal
<input type="checkbox"/> Greece	<input type="checkbox"/> Spain
<input type="checkbox"/> Iceland	<input type="checkbox"/> Sweden
<input checked="" type="checkbox"/> Ireland	<input type="checkbox"/> Switzerland
<input checked="" type="checkbox"/> Italy	<input checked="" type="checkbox"/> United Kingdom

### Telecom Approval Notice

This equipment has been tested and found to comply with the following standards (which are no longer required for compliance).

#### Tested by

##### GE Interlogix

CTR21 (1998)  
+EG201 121 (1998)

##### Enterprise, Ireland

**Report: 28/117218/1/ITO**  
TBR21

This equipment has been approved in accordance with the Council Decision 98/482/EC for pan-European, single terminal connection to the public switched telephone network (PSTN). However, due to the differences between the individual PSTNs provided in different countries, the approval does not, of itself, give an unconditional assurance of successful operation on every PSTN network termination point. In the event of problems, you should contact your equipment supplier in the first instance.

### Electrical Requirements

This device automatically adjusts to voltages within the range of 220 - 240 V 50 Hz.

Fuse: T 500 mA 250 VAC for model numbers 60-840-43 and 60-857-43. Fuse: T 315 mA 250 VAC for model number 60-868-43

### Technical Service and Repair

If you experience trouble with this equipment, please contact your installer for service and repair information.

Changes or modifications not expressly approved can void the user's authority to operate the equipment.

**Notes:**

---



**GE Interlogix**

---

©2002 GE Interlogix. All trademarks are properties of their owners

*2266 Second Street North  
North Saint Paul, MN 55109*

All rights reserved.