

Fire Alarm Control Panel
MS-5024UD/MS-5024UDE

Fire Alarm System Limitations

An automatic fire alarm system—typically made up of smoke detectors, heat detectors, manual pull stations, audible warning devices, and a fire alarm control with remote notification capability—can provide early warning of a developing fire. Such a system, however, does not assure protection against property damage or loss of life resulting from a fire.

The Manufacturer recommends that smoke and/or heat detectors be located throughout a protected premise following the recommendations of the current edition of the National Fire Protection Association Standard 72 (NFPA 72), manufacturer's recommendations, State and local codes, and the recommendations contained in the Guide for Proper Use of System Smoke Detectors, which is made available at no charge to all installing dealers. A study by the Federal Emergency Management Agency (an agency of the United States government) indicated that smoke detectors may not go off in as many as 35% of all fires. While fire alarm systems are designed to provide early warning against fire, they do not guarantee warning or protection against fire. A fire alarm system may not provide timely or adequate warning, or simply may not function, for a variety of reasons:

Smoke detectors may not sense fire where smoke cannot reach the detectors such as in chimneys, in or behind walls, on roofs, or on the other side of closed doors. Smoke detectors also may not sense a fire on another level or floor of a building. A second-floor detector, for example, may not sense a first-floor or basement fire.

Particles of combustion or "smoke" from a developing fire may not reach the sensing chambers of smoke detectors because:

- Barriers such as closed or partially closed doors, walls, or chimneys may inhibit particle or smoke flow.
- Smoke particles may become "cold," stratify, and not reach the ceiling or upper walls where detectors are located.
- Smoke particles may be blown away from detectors by air outlets.
- Smoke particles may be drawn into air returns before reaching the detector.

The amount of "smoke" present may be insufficient to alarm smoke detectors. Smoke detectors are designed to alarm at various levels of smoke density. If such density levels are not created by a developing fire at the location of detectors, the detectors will not go into alarm.

Smoke detectors, even when working properly, have sensing limitations. Detectors that have photoelectronic sensing chambers tend to detect smoldering fires better than flaming fires, which have little visible smoke. Detectors that have ionizing-type sensing chambers tend to detect fast-flaming fires better than smoldering fires. Because fires develop in different ways and are often unpredictable in their growth, neither type of detector is necessarily best and a given type of detector may not provide adequate warning of a fire.

Smoke detectors cannot be expected to provide adequate warning of fires caused by arson, children playing with matches (especially in bedrooms), smoking in bed, and violent explosions (caused by escaping gas, improper storage of flammable materials, etc.).

While a fire alarm system may lower insurance rates, it is not a substitute for fire insurance!

Heat detectors do not sense particles of combustion and alarm only when heat on their sensors increases at a predetermined rate or reaches a predetermined level. Rate-of-rise heat detectors may be subject to reduced sensitivity over time. For this reason, the rate-of-rise feature of each detector should be tested at least once per year by a qualified fire protection specialist. *Heat detectors are designed to protect property, not life.*

IMPORTANT! Smoke detectors must be installed in the same room as the control panel and in rooms used by the system for the connection of alarm transmission wiring, communications, signaling, and/or power. If detectors are not so located, a developing fire may damage the alarm system, crippling its ability to report a fire.

Audible warning devices such as bells may not alert people if these devices are located on the other side of closed or partly open doors or are located on another floor of a building. Any warning device may fail to alert people with a disability or those who have recently consumed drugs, alcohol or medication. Please note that:

- Strobes can, under certain circumstances, cause seizures in people with conditions such as epilepsy.
- Studies have shown that certain people, even when they hear a fire alarm signal, do not respond or comprehend the meaning of the signal. It is the property owner's responsibility to conduct fire drills and other training exercise to make people aware of fire alarm signals and instruct them on the proper reaction to alarm signals.
- In rare instances, the sounding of a warning device can cause temporary or permanent hearing loss.

A fire alarm system will not operate without any electrical power. If AC power fails, the system will operate from standby batteries only for a specified time and only if the batteries have been properly maintained and replaced regularly.

Equipment used in the system may not be technically compatible with the control. It is essential to use only equipment listed for service with your control panel.

Telephone lines needed to transmit alarm signals from a premise to a central monitoring station may be out of service or temporarily disabled. For added protection against telephone line failure, backup radio transmission systems are recommended.

The most common cause of fire alarm malfunction is inadequate maintenance. To keep the entire fire alarm system in excellent working order, ongoing maintenance is required per the manufacturer's recommendations, and UL and NFPA standards. At a minimum, the requirements of Chapter 7 of NFPA 72 shall be followed. Environments with large amounts of dust, dirt or high air velocity require more frequent maintenance. A maintenance agreement should be arranged through the local manufacturer's representative. Maintenance should be scheduled monthly or as required by National and/or local fire codes and should be performed by authorized professional fire alarm installers only. Adequate written records of all inspections should be kept.

Installation Precautions

WARNING - Several different sources of power can be connected to the fire alarm control panel. Disconnect all sources of power before servicing. Control unit and associated equipment may be damaged by removing and/or inserting cards, modules, or interconnecting cables while the unit is energized. Do not attempt to install, service, or operate this unit until this manual is read and understood.

CAUTION - *System Reacceptance Test after Software Changes.* To ensure proper system operation, this product must be tested in accordance with NFPA 72 Chapter 7 after any programming operation or change in site-specific software. Reacceptance testing is required after any change, addition or deletion of system components, or after any modification, repair or adjustment to system hardware or wiring.

All components, circuits, system operations, or software functions known to be affected by a change must be 100% tested. In addition, to ensure that other operations are not inadvertently affected, at least 10% of initiating devices that are not directly affected by the change, up to a maximum of 50 devices, must also be tested and proper system operation verified.

This system meets NFPA requirements for operation at 0-49° C/32-120° F and at a relative humidity of 85% RH (non-condensing) at 30° C/86° F. However, the useful life of the system's standby batteries and the electronic components may be adversely affected by extreme temperature ranges and humidity. Therefore, it is recommended that this system and all peripherals be installed in an environment with a nominal room temperature of 15-27° C/60-80° F.

Verify that wire sizes are adequate for all initiating and indicating device loops. Most devices cannot tolerate more than a 10% I.R. drop from the specified device voltage.

Adherence to the following will aid in problem-free installation with long-term reliability:

Like all solid state electronic devices, this system may operate erratically or can be damaged when subjected to lightning-induced transients. Although no system is completely immune from lightning transients and interferences, proper grounding will reduce susceptibility. *Overhead or outside aerial wiring is not recommended, due to an increased susceptibility to nearby lightning strikes.* Consult with the Technical Services Department if any problems are anticipated or encountered.

Disconnect AC power and batteries prior to removing or inserting circuit boards. Failure to do so can damage circuits.

Remove all electronic assemblies prior to any drilling, filing, reaming, or punching of the enclosure. When possible, make all cable entries from the sides or rear. Before making modifications, verify that they will not interfere with battery, transformer, and printed circuit board location.

Do not tighten screw terminals more than 9 in-lbs. Over-tightening may damage threads, resulting in reduced terminal contact pressure and difficulty with screw terminal removal.

Though designed to last many years, system components can fail at any time. This system contains static-sensitive components. Always ground yourself with a proper wrist strap before handling any circuits so that static charges are removed from the body. Use static-suppressive packaging to protect electronic assemblies removed from the unit.

Follow the instructions in the installation, operating, and programming manuals. These instructions must be followed to avoid damage to the control panel and associated equipment. FACP operation and reliability depend upon proper installation by authorized personnel.

FCC Warning

WARNING: This equipment generates, uses, and can radiate radio frequency energy and if not installed and used in accordance with the instruction manual, may cause interference to radio communications. It has been tested and found to comply with the limits for class A computing device pursuant to Subpart B of Part 15 of FCC Rules, which is designed to provide reasonable protection against such interference when operated in a commercial environment.

Operation of this equipment in a residential area is likely to cause interference, in which case the user will be required to correct the interference at his own expense.

Notes

Table of Contents

CHAPTER 1: Product Description	10
1.1: Product Features	10
FIGURE 1-1: Optional DP-5024UD.....	11
FIGURE 1-2: MS-5024UD Panel.....	12
1.2: Controls and Indicators	13
FIGURE 1-3: Controls and Indicators	13
1.3: Circuits	13
1.4: Digital Communicator.....	14
1.5: Components.....	14
1.5.1: Main Circuit Board	14
1.5.2: Cabinet	14
1.5.3: Transformer Assembly	15
FIGURE 1-4: XRM-24(E) Transformer	15
1.5.4: Batteries	15
1.6: Optional Devices	15
1.6.1: RM-5F Five-Zone Relay Module	15
1.6.2: CAC-5F Class A Converter Module.....	15
1.6.3: ADM-24 Annunciator Driver Module	15
1.6.4: RZA-5F Remote Annunciator.....	15
1.6.5: PRT-24 Printer Interface Module.....	16
1.6.6: DP-5024UD Dress Panel	16
1.6.7: BB-17F Battery Box	16
1.6.8: PK-5024UD Programming Kit	16
1.7: Specifications	16
1.8: Telephone Requirements and Warnings	18
1.8.1: Telephone Circuitry.....	18
1.8.2: Digital Communicator.....	18
1.8.3: Telephone Company Rights and Warnings	18
CHAPTER 2: Installation.....	19
2.1: Mounting Options	19
FIGURE 2-1: MS-5024UD Cabinet	19
2.2: Backbox Mounting.....	19
FIGURE 2-2: Cabinet Dimensions and Knockout Locations.....	20
FIGURE 2-3: Backbox and Battery Box	21
2.3: Operating Power.....	22
FIGURE 2-4: Operating Power Connections.....	22
2.4: Input Circuits.....	23
FIGURE 2-5: Typical Initiating Device Circuit Connections	23
2.5: Output Circuits	24
FIGURE 2-6: Auxiliary Power Connections	24
FIGURE 2-7: Notification Appliance Circuit Connections	24
FIGURE 2-8: Auxiliary Relay and Relay Driver Terminals	25
2.6: UL Power-limited Wiring Requirements	26
FIGURE 2-9: Typical Wiring Diagram for UL Power-limited Requirements	26
2.7: Digital Communicator.....	27
FIGURE 2-10: Wiring Phone Jacks.....	27
2.8: Optional Boards.....	28
2.8.1: ADM-24 Annunciator Driver Module	28
FIGURE 2-11: ADM-24 Annunciator Driver Module	28
2.8.2: RZA-5F Remote Annunciator	28
FIGURE 2-12: RZA-5F	28

Table of Contents

FIGURE 2-13: Wiring the RZA-5F/ADM-2429

FIGURE 2-14: Installing the Annunciator (Single-Gang Electrical Box)29

2.8.3: PRT-24 Printer Interface Module30

FIGURE 2-15: Remote Printer Connections.....30

2.8.4: RM-5F Five-Zone Relay Module.....31

FIGURE 2-16: RM-5F Installation and Wiring31

2.8.5: CAC-5F Class A Converter Module32

FIGURE 2-17: CAC-5F Style D Converter32

CHAPTER 3: Programming Instructions33

3.1: Entering Program Mode33

3.2: Switch Functions34

FIGURE 3-1: Control Panel Keypad34

3.3: Programming Options34

TABLE 3-1: Primary Event Codes - 3+1, 4+1 Express, 4+1 Standard, Expanded & 4+2 Expanded .36

TABLE 3-2: Primary Event Codes - 4+2 Standard and 4+2 Express.....37

TABLE 3-3: Event Codes, Primary Central Station Number38

TABLE 3-4: Secondary Event Codes-3+1, 4+1 Express, 4+1 Standard, Expanded & 4+2 Expanded41

TABLE 3-5: Secondary Event Codes - 4+2 Standard and 4+2 Express42

TABLE 3-6: Event Codes, Secondary Central Station Number43

FIGURE 3-2: Verification Timing Diagram.....44

TABLE 3-7: Zone Function Selection45

3.4: Default Programming49

CHAPTER 4: Operating Instructions50

4.1: Switches in Normal Mode50

4.1.1: RESET.....50

4.2: Displays51

FIGURE 4-1: Phone Connectors and LEDs.....52

4.3: Operation53

4.3.1: Alarm Response53

4.3.2: Alarm Restoral54

4.3.3: System Supervisory Condition Response54

4.3.4: System Supervisory Restoral Response54

4.3.5: Trouble Condition Response55

4.3.6: Trouble Condition Restoral55

4.3.7: Off Normal Reporting55

4.3.8: Zone Disable/Enable56

4.3.9: Fire Drill.....56

4.4: Central Station Communications.....57

TABLE 4-1: Format Selection Address (16 & 42)58

TABLE 4-2: Format Selection Address Explanation.....59

4.4.1: Transmittal Priorities60

TABLE 4-3: Compatible UL Listed Receivers.....61

CHAPTER 5: Servicing.....62

5.1: Walktest Mode.....62

5.2: History Mode.....63

5.3: Troubleshoot Mode.....64

5.3.1: Zone Voltages64

TABLE 5-1: Nominal Zone Voltages64

5.3.2: AC Line Voltage.....65

5.3.3: Battery Voltage65

5.3.4: Telephone Lines65

FIGURE 5-1: Phone Connectors and LEDs.....65

TABLE 5-2: AC Line Voltage Range.....65

Table of Contents

TABLE 5-3: Battery Voltage 65

5.3.5: NAC 1 & 2 66

5.3.6: Resettable Power 66

5.4: Lamp Test 66

5.5: Print Mode 66

CHAPTER 6: Slave Communicator Configuration 67

FIGURE 6-1: Slave Communicator Connections 68

CHAPTER 7: Remote Site Upload/Download 69

7.1: Downloading Program 69

7.1.1: Security Features 70

7.2: Downloading Initiated at Control Panel 71

7.3: Downloading Initiated at a Service Terminal 71

7.4: Uploading Initiated at a Service Terminal 72

Appendix A: Battery Calculations 73

TABLE A-1: Battery Calculations 73

A.1: The Main Power Supply 74

TABLE A-2: Filtered Load in Standby - external devices connected to TB4 only 74

TABLE A-3: Filtered Load in Alarm 75

Appendix B: Programming Reference Sheets 76

Appendix C: Operation and Function Modes 82

C.1: Operation Modes 82

C.2: Function Modes 82

TABLE C-1: Operation Modes 82

TABLE C-2: Function Modes 82

Appendix D: Ademco Contact ID Format Event Code Descriptions 83

This control panel has been designed to comply with standards set forth by the following regulatory agencies:

- Underwriters Laboratories Standard UL 864
- NFPA 72 National Fire Alarm Code for Local, Remote Station and Central Station Fire Alarm System

Before proceeding, the installer should be familiar with the following documents.



NFPA Standards

This Fire Alarm Control Panel complies with the following NFPA Standards:

NFPA 72 National Fire Alarm Code for Central Station Fire Alarm Systems Protected Premises Unit (Automatic, Manual and Waterflow), Local Fire Alarm Systems (Automatic, Manual, Waterflow and Sprinkler Supervisory), Auxiliary Protective Fire Alarm Systems (Automatic, Manual and Waterflow), Proprietary Protective Fire Alarm Systems (Automatic, Manual and Waterflow) and Remote Station Fire Alarm Systems (Automatic, Manual and Waterflow).



Underwriters Laboratories Documents:

UL 38 Manually Actuated Signaling Boxes
UL 217 Smoke Detectors, Single and Multiple Station
UL 228 Door Closers–Holders for Fire Protective Signaling Systems
UL 268 Smoke Detectors for Fire Protective Signaling Systems
UL 268A Smoke Detectors for Duct Applications
UL 346 Waterflow Indicators for Fire Protective Signaling Systems
UL 464 Audible Signaling Appliances
UL 521 Heat Detectors for Fire Protective Signaling Systems
UL 864 Standard for Control Units for Fire Protective Signaling Systems
UL 1481 Power Supplies for Fire Protective Signaling Systems
UL 1638 Visual Signaling Appliances
UL 1971 Signaling Devices for Hearing Impaired

Other:

NEC Article 250 Grounding
NEC Article 300 Wiring Methods
NEC Article 760 Fire Protective Signaling Systems
Applicable Local and State Building Codes
Requirements of the Local Authority Having Jurisdiction (LAHJ)

Fire•Lite Documents

Fire•Lite Device Compatibility Document Document #15384

MS-5024UD Main Circuit Board

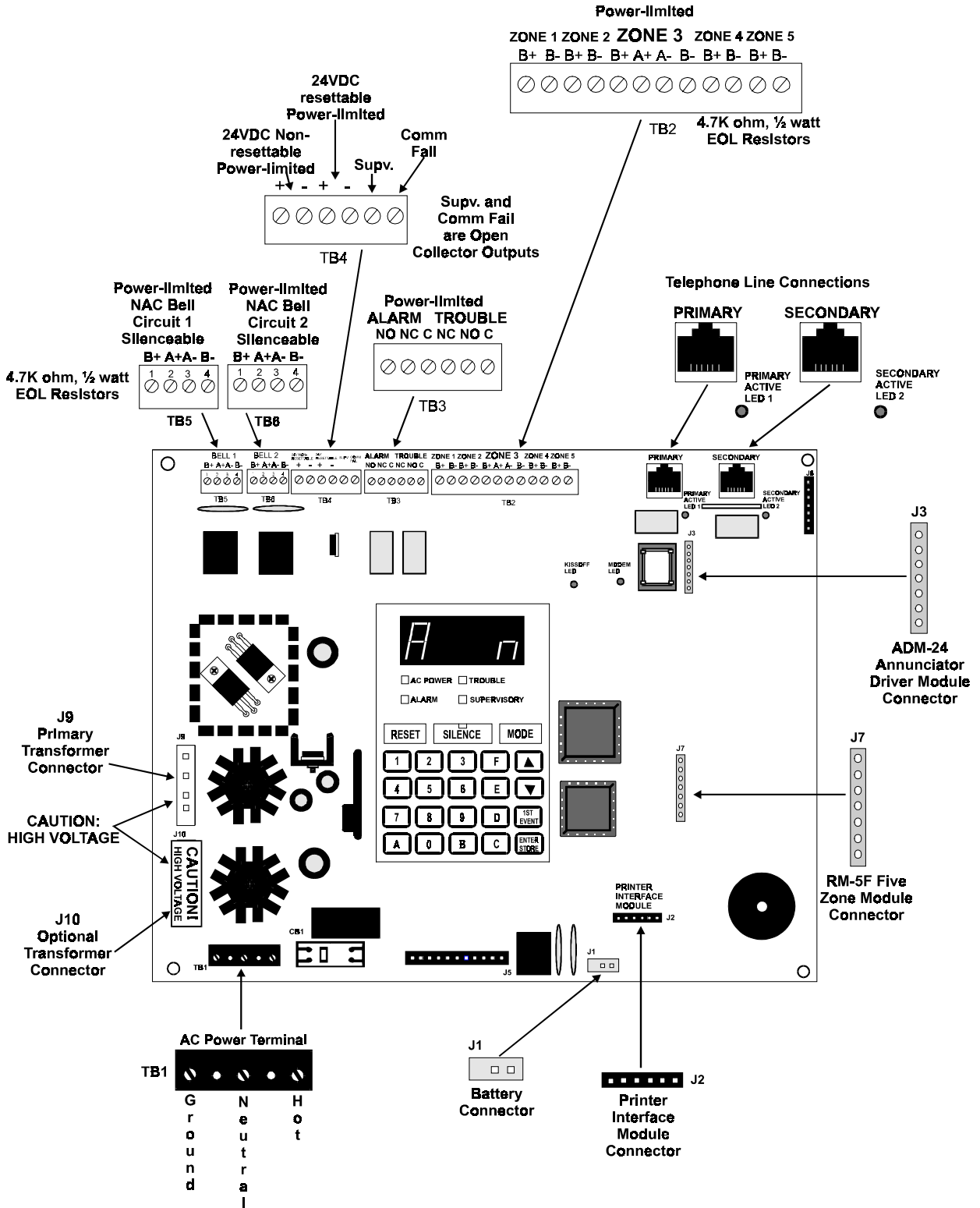

CHAPTER 1 *Product Description*

The MS-5024UD is a combination FACP (Fire Alarm Control Panel) and DACT (Digital Alarm Communicator Transmitter) all on one circuit board. It is a five-zone panel which uses conventional input devices. The panel accepts waterflow devices, two-wire smoke detectors, four-wire smoke detectors, pull stations and other normally open contact devices. Outputs include two NACs (Notification Appliance Circuits), alarm and trouble relays, supervisory and communicator failure relay drivers.

The integral communicator transmits system status (alarms, troubles, AC loss, etc.) to UL-listed Central Stations via the public switched telephone network. The control panel has a built-in programmer and may also serve as a slave communicator to a host panel. It also supervises all wiring, AC voltage, telephone line input voltage and battery level.

The control panel may be programmed or interrogated off-site via the public switched telephone network. Any IBM compatible personal computer with DOS™ 4.01 or greater plus Windows™ 3.1 or greater, with a 1200 baud Hayes™ compatible modem and Fire•Lite Upload/Download software P/N PK-5024UD, may serve as a Service Terminal. This allows download of the entire program or upload of the entire program, history file, walktest data, current status and system voltages. The MS-5024UDE offers the same features as the MS-5024UD but allows connection to 220/240 VAC input.

1.1 Product Features

- Selectable as Fire Panel, Fire Panel/Communicator or Slave Communicator
- Programmable Zone ID: 2-wire smoke, pull station, normally open contact device, supervisory, supervisory autosilence, waterflow silenceable or waterflow nonsilenceable
- One Style D (Class A) zone
- Four Style B (Class B) zones
- 3.6 amps usable power expandable to 5.6 amps
- Optional 5-zone Relay Module (RM-5F)
- CAC-5F Style D (Class A) Zone Converter Module
- Two NFPA Style Y (Class B) or Style Z (Class A) Notification Appliance (bell) Circuits
- Built-in programmer
- Built-in voltmeter
- Telephone Line Active LED indicators
- Communication confirmation (Kissoff) LED
- Disable report by event
- Programmable event codes
- 24 volt operation
- Real-Time clock and calendar
- Trouble reminder
- Alarm verification
- RZA-5F remote annunciator (requires ADM-24 Annunciator Driver Module)
- Small size - 15" (38.1 cm) x 14.5" (36.83 cm) x 2.75" (6.985 cm)
- History file with 32 event storage
- Silence inhibit per NAC (Notification Appliance Circuit)
- Autosilence per NAC

Product Features

- Touchtone/Rotary dialing
- Programmable make/break ratio
- Fuseless design
- PRT-24 (Printer Interface Module)
- Print real-time system status
- Print history and walktest files, program contents and troubleshoot mode voltages
- PK-5024UD Upload/Download Software Kit
- Number of dial attempts (minimum of 5 and maximum of 10)
- Programmable channel ID (slave)
- Programmable zone delay (waterflow only)
- Form-C alarm and trouble relays
- Supervisory and communication fail relay drivers
- Low AC voltage sense
- One-man walktest
- Optional Dress Panel cover (DP-5024UD)

FIGURE 1-1: Optional DP-5024UD

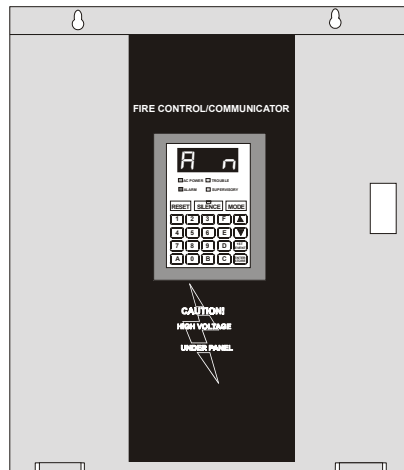

Note: Unless otherwise specified, MS-5024UD shall be used in this manual to refer to both the MS-5024UD and MS-5024UDE Fire Alarm Control Communicators.

FIGURE 1-2: MS-5024UD Panel

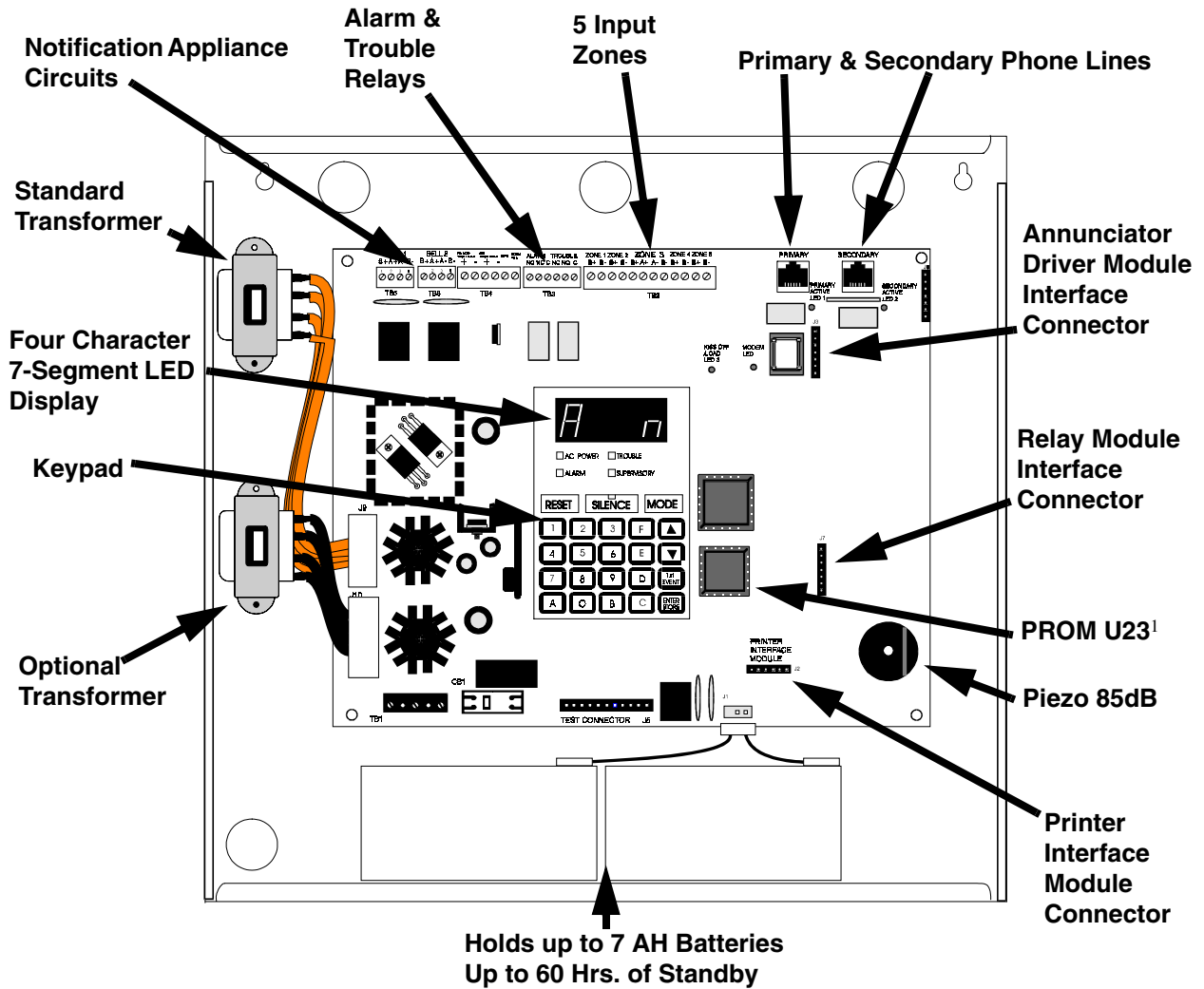

1. Software for the Fire Alarm Control Communicator is located in a PROM inserted in the IC socket labeled U23. The MS-5024UD and MS-5024UDE each contain unique software. For specific panel software information, refer to the MS-5024UD(E) Field Software Change Procedure Document #50125.

1.2 Controls and Indicators

Front Panel Switches

RESET	Digits 0-9
SILENCE	A
MODE	B
Up Arrow	C
Down Arrow	D
1st EVENT	E
ENTER/STORE	F

Displays

- Alarm - red LED
- Trouble - yellow LED
- Supervisory - yellow LED
- AC Power - green LED
- Four 7-Segment Displays - red
- Primary Phone Line Active - red LED
- Secondary Phone Line Active - red LED
- 'Kissoff' Signal from Central Station - green LED
- Silence - yellow LED
- Modem - green LED

FIGURE 1-3: Controls and Indicators

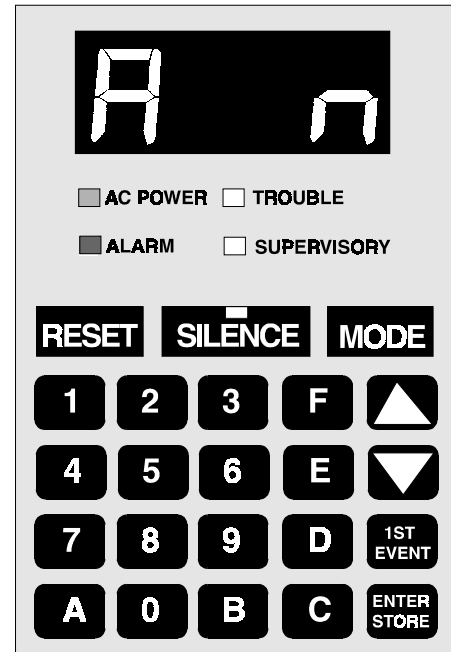

Local Piezo Sounder

A piezo sounder provides separate and distinct sounds for alarm, trouble and supervisory conditions.

1.3 Circuits

Input Circuits

Five input circuits provide Style B configuration with one circuit also configurable for Style D. Input circuits may be used as standard fire control panel zones or slave communicator input channels.

- Initiating Device Circuit 1 (Style B) accepts normally open contact devices and 2-wire smoke detectors
- Initiating Device Circuit 2 (Style B) accepts normally open contact devices and 2-wire smoke detectors
- Initiating Device Circuit 3 (Style B/D) accepts normally open contact devices, 2-wire smoke detectors and waterflow devices
- Initiating Device Circuit 4 (Style B) accepts normally open contact devices and 2-wire smoke detectors
- Initiating Device Circuit 5 (Style B) accepts normally open contact devices and 2-wire smoke detectors

Output Circuits

- 24 Volt Resettable Power Output
- 24 Volt Nonresettable Power Output
- Primary Telephone Line
- Secondary Telephone Line
- 24 Volt Battery Charger
- Printer Port

Digital Communicator

Notification Appliance Circuits

Two Notification Appliance Circuits configurable for Style Y (Class B) or Style Z (Class A) with various programmable features.

Relays

Two dry Form-C relay contacts for system alarm and system trouble are provided. Contacts are rated 2 amps @ 30 VDC and 0.5 amps @ 30 VAC resistive.

Relay Drivers

Two relay driver outputs for supervisory and communication failure are available.

1.4 Digital Communicator

Two modular phone jacks allow easy connection to telephone lines. Modular jacks are labeled PH1 and PH2 for the Primary and Secondary phone lines. Telephone line active red LEDs are provided as well as a green 'kissoff' LED. The integral digital communicator provides the following functions:

- Line Seizure - takes control of the phone lines disconnecting any premises phones
- Off/On Hook - perform on and off-hook status to the phone lines
- Listen for dial tone - 440 hertz tone typical in most networks
- Dialing the Central Station(s) phone number - default is Touch-Tone®, programmable to rotary
- For tone burst or touchtone type formats: Discern proper 'Ack' and 'kissoff' tone(s). The frequency and time duration of the tone(s) varies with the transmission format. The control panel will adjust accordingly
- Communicate in the following formats:
 - ✓ 12 Tone Burst Types (20 pps):
(3+1, 4+1, 3+1 Expanded, 4+1 Expanded and 4+2 Expanded)
 - ✓ 3 Touchtone Types:
4+1 Ademco Express
4+2 Ademco Express
Ademco Contact ID
(see Table 4-3 for a list of compatible receivers)

1.5 Components

1.5.1 Main Circuit Board

The main circuit board contains the system's CPU, power supply, other primary components and wiring interface connectors. Optional modules plug in and are mounted to the main circuit board. The main circuit board is delivered premounted in the cabinet.

1.5.2 Cabinet

The cabinet is red with an attractive navy blue front overlay. The backbox measures 15" (38.1 cm) x 14.5" (36.83 cm) x 2.75" (6.985 cm) and provides space for two batteries (up to 7 Amp Hours). Also available is an optional dress panel (DP-5024UD), which mounts inside the cabinet.

1.5.3 Transformer Assembly

One 100VA transformer is provided standard with the panel (3.6 amps maximum). An optional 100VA transformer, XRM-24 (XRM-24E for MS-5024UDE), is available to provide maximum accessory power (6.6 amps maximum).

1.5.4 Batteries

The cabinet provides space for 7 Amp Hour batteries (for 12 Amp Hour up to 18 Amp Hour batteries, use the listed BB-17F battery box). Batteries must be ordered separately.

1.6 Optional Devices

1.6.1 RM-5F Five-Zone Relay Module

The RM-5F option module provides five Form-C relays which track zones 1 through 5. The module mounts to connector J7 on the lower right side of the main circuit board. Refer to Figure 1-2, “MS-5024UD Panel,” on page 12 and Figure 2-16 on page 31.

1.6.2 CAC-5F Class A Converter Module

The CAC-5F Class A Converter module converts the Style B (Class B) Initiating Device Circuits to Style D (Class A). The CAC-5F mounts to terminal block TB2, located in the upper center of the main circuit board. The removable terminal block on the CAC-5F module provides for ease of wiring. Refer to Figure 2-17, “CAC-5F Style D Converter,” on page 32

1.6.3 ADM-24 Annunciator Driver Module

The ADM-24 Annunciator Driver Module supports the RZA-5F Remote Annunciator module. Annunciator wiring is supervised for open circuits by this module. The Annunciator Driver Module mounts to connector J3 in the upper right corner of the main circuit board. Refer to Figure 1-2, “MS-5024UD Panel,” on page 12 and Figure 2-11 on page 28.

1.6.4 RZA-5F Remote Annunciator

The RZA-5F Remote Annunciator mounts on a standard single-gang box and provides LED indication of the following:

- Alarm Zone 1 (red)
- Alarm Zone 2 (red)
- Alarm Zone 3 (red)
- Alarm Zone 4 (red)
- Alarm Zone 5 (red)
- System Trouble (yellow)

A Local Trouble Sounder and Tone Silence Switch are also provided. All LEDs and their wiring are supervised for open conditions. Any open condition will cause the System Trouble LED to illuminate. Slide-in paper labels permit an easy change of zone information. Refer to Figure 2-12, “RZA-5F,” on page 28, Figure 2-13 on page 29 and Figure 2-14 on page 29. *Note that the Remote Annunciator requires the use of the ADM-24 Annunciator Driver Module.*

FIGURE 1-4: XRM-24(E) Transformer

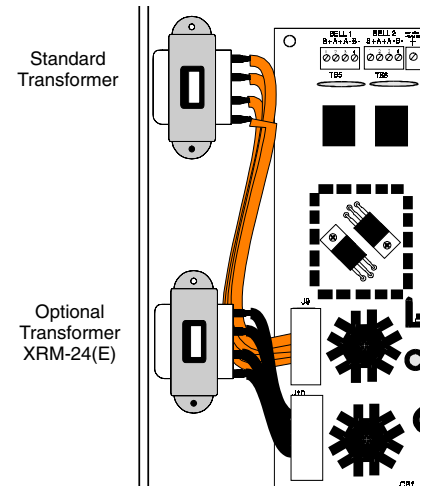

Specifications

1.6.5 PRT-24 Printer Interface Module

The Printer Interface Module may be used to connect a printer to the control panel for the purpose of printing a history report, walktest file, troubleshoot report, program entries or current system status. Printers require separate external primary power. Connect the PRT-24 module (with cable) to the serial EIA-232 port on the printer. The module mounts to the J2 connector on the main circuit board. *Note that an EDP listed printer must be used if the printer will be permanently attached to the control panel. Refer to Figure 2-15, "Remote Printer Connections," on page 30.*

1.6.6 DP-5024UD Dress Panel

A red dress panel is available as an option. The dress panel restricts access to the system wiring while allowing access to the membrane switch panel. Refer to Figure 1-1, "Optional DP-5024UD," on page 11.

1.6.7 BB-17F Battery Box

The BB-17F battery box may be used to house two batteries, from 12 Amp Hour to 18 Amp Hour. The battery box mounts directly below the cabinet and main circuit board. Refer to Figure 2-3, "Backbox and Battery Box," on page 21. The BB-17F is red and is provided with knockouts.

1.6.8 PK-5024UD Programming Kit

This kit includes one 3½" diskette plus Instruction Manual P/N 50041. When the software is loaded into an IBM compatible computer, it creates an off-line Service Terminal that allows any MS-5024UD panel to be uploaded or downloaded over standard telephone lines.

1.7 Specifications

AC Power - TB1

MS-5024UD: 120 VAC, 60 Hz, 2.3 amps

MS-5024UDE: 220/240 VAC, 50 Hz, 1.2 amps

Wire size: minimum #14 AWG (2 mm²) with 600V insulation

Battery (lead acid only) - J1

Maximum Charging Circuit: Normal Flat Charge - 27.6V @ 0.8 amp

Maximum Charger Capacity: 17 Amp Hour battery. (MS-5024UD cabinet holds maximum 7 Amp Hour battery.

Larger batteries require Fire•Lite BB-17F or other UL listed battery cabinet).

Initiating Device Circuits - TB2

Detector Zones 1, 2, 3, 4, 5

Power-limited Circuitry

Operation: All zones are NFPA Style B, Zone 3 is NFPA Style B or Style D. Use CAC-5F module for Style D operations

Normal Operating Voltage: 24 VDC (ripple = 100 mV maximum)

Alarm Current: 26 mA

Short Circuit Current: 42 mA maximum

Maximum Loop Resistance: 100 ohms

End-of-Line Resistor: 4.7K ohms, ½ watt (P/N 27072 UL listed)

Detector Loop Current is sufficient to ensure operation of one alarmed detector per zone

Standby Current: 7.26 mA (includes ELR and 2 mA maximum detector current)

Smoke Detector Identifier A

Refer to Fire•Lite Device Compatibility Document for listed compatible devices

Specifications

Notification Appliance Circuits - TB5 & TB6

Nonregulated, special purpose power, Styles Y and Z supported

Power-limited circuitry

Operating Voltage: Nominal 24 volts

Current for all external devices: 3.0 amps expandable to 5.6 amps

Current-limit: PTC

Maximum signaling current/circuit: 2.5 amps

End-of-Line resistor: 4.7K ohms, ½ watt (P/N 71252 UL listed) for NACs

Refer to Fire•Lite Device Compatibility Document for listed compatible devices

Alarm and Trouble Relays - TB3

Contact rating: 2.0 amps @ 30 VDC (resistive), 0.5 amps @ 30 VAC (resistive)

Alarm and Trouble: Form-C power-limited circuitry (see Figure 2-7 note for power-limited wiring application)

Auxiliary Outputs - TB4, Terminals 5 & 6

TB4-5 Supervisory Relay Driver: Normally high, active low, sinks up to 40 mA

TB4-6 Communication Failure: Normally high, active low, sinks up to 40 mA

Power-limited circuitry

Four-wire Smoke Detector Power - TB4, Terminals 3(+) & 4(-)

Maximum ripple voltage: 10 mV_{RMS} Operating voltage: Nominal 24 volts

Up to 300 mA is available for powering 4-wire smoke detectors

Power-limited circuitry

Recommended maximum standby current is 50 mA (see Battery Calculations in Appendix A)

Refer to Fire•Lite Device Compatibility Document for compatible listed devices

Nonresettable Filtered 24V Power - TB4 Terminals 1(+) & 2(-)

Maximum ripple voltage: 10 mV_{RMS} Operating voltage: Nominal 24 volts

Total DC current available from this output is up to 300 mA

Power-limited circuitry

Recommended maximum standby current is 150 mA (see Battery Calculations in Appendix A)

Refer to Fire•Lite Device Compatibility Document for compatible listed devices

Notes:

1. For power supply calculations, refer to Appendix A.
2. Total current for nonresettable power, 4-wire smoke detector power and two Notification Appliance Circuits *must not exceed 5.6 amps*. Total external system current in excess of 3.6 amps requires the XRM-24 Transformer (XRM-24E for 220/240 VAC applications) and 12 Amp Hour or 17 Amp Hour batteries.

1.8 Telephone Requirements and Warnings

1.8.1 Telephone Circuitry

Ringer Equivalence Number (REN) = 1.3B
AC Impedance: 10.0 Mega Ohm
Complies with FCC Part 68
Mates with RJ31X Male Connector
Supervision Threshold: less than 4.0 volts for 2 minutes

The REN is used to determine the quantity of devices which may be connected to the telephone line. Excessive RENs on the telephone line may result in the devices not ringing in response to an incoming call. In most, but not all areas, the sum of the RENs should not exceed five (5.0). To be certain of the number of devices that may be connected to the line as determined by the total RENs, contact the telephone company to determine the maximum REN for the calling area.

1.8.2 Digital Communicator

Before connecting the control panel to the public switched telephone network, the installation of two RJ31X jacks is necessary. The following information is provided if required by the local telephone company:

Manufacturer: Fire•Lite Alarms, Inc.
One Fire-Lite Place
Northford, CT 06472

Product Model Number: MS-5024UD
FCC Registration Number: 1W6USA-20004-AL-E
Ringer Equivalence 1.3B

Note: The FCC ID label is located on the inside of the control panel door

1.8.3 Telephone Company Rights and Warnings

The telephone company, under certain circumstances, may temporarily discontinue services and/or make changes in its facilities, services, equipment or procedures which may affect the operation of this control panel. However, the telephone company is required to give advance notice of such changes or interruptions.

If the control panel causes harm to the telephone network, the telephone company reserves the right to temporarily discontinue service. Advance notification will be provided except in cases when advance notice is not practical. In such cases, notification will be provided as soon as possible. The opportunity will be given to correct any problems and to file a complaint.

DO NOT CONNECT THIS PRODUCT TO COIN TELEPHONE, GROUND START, OR PARTY LINE SERVICES.

When the control panel activates, premise phones will be disconnected

Two separate phone lines are required. Do not connect both telephone interfaces to the same telephone line.

The control panel must be connected to the public switched telephone network upstream of any private telephone system at the protected premises.

An FCC compliant telephone cord must be used with this equipment. This equipment is designed to be connected to the telephone network or premises wiring using a compatible RJ31X male modular plug which is Part 68 compliant.

CHAPTER 2 *Installation*

2.1 Mounting Options

The cabinet may be either surface mounted or semi-flush mounted using the optional Trim Ring P/N: **TR-1-R**. The door is removable during the installation period by opening and lifting the door off the hinges. The cabinet mounts using two key slots and two additional 0.25" (6.35 mm) diameter holes located in the backbox. The key slots are located at the top of the backbox and the two securing holes at the bottom.

Carefully unpack the system and check for shipping damage. Mount the cabinet in a clean, dry, vibration-free area where extreme temperatures are not encountered. The area should be readily accessible with sufficient room to easily install and maintain the panel. Locate the top of the cabinet approximately five feet above the floor with the hinge mounting on the left. Determine the number of conductors required for the devices to be installed. Sufficient knockouts are provided for wiring convenience. Select the appropriate knockout(s) and pull the required conductors into the box. Note that there are no knockouts on the left (hinged) side of the cabinet. All wiring should be in accordance with the National and/or Local codes for fire alarm systems.

FIGURE 2-1: MS-5024UD Cabinet



2.2 Backbox Mounting

- ✓ Open the door and lift the door off the pin hinges
- ✓ Remove the main PC board assembly by unscrewing the four screws in the corners of the board. Two standoffs support the board in the center. Set the board aside in a safe, clean place. Avoid static discharge which may damage the board.
- ✓ Mark and predrill holes for the top two keyhole mounting bolts using the dimensions shown
- ✓ Install two upper fasteners in the wall with the screw heads protruding
- ✓ Using the proper 'keyholes', mount the backbox over the two screws
- ✓ Mark and drill the lower two holes
- ✓ Mount backbox, install remaining fasteners and tighten
- ✓ When the location is dry and free of construction dust, reinstall the main PC board

FIGURE 2-2: Cabinet Dimensions and Knockout Locations

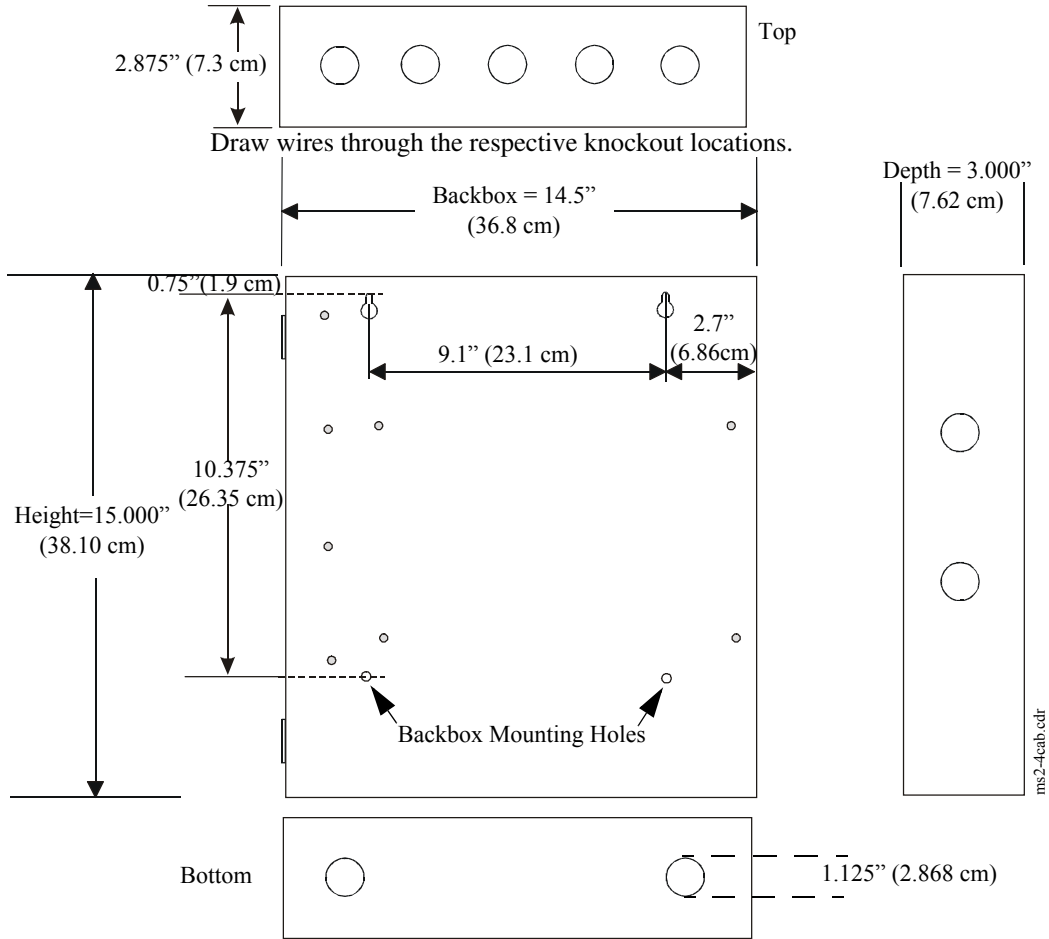

TR-1-R Trim Ring

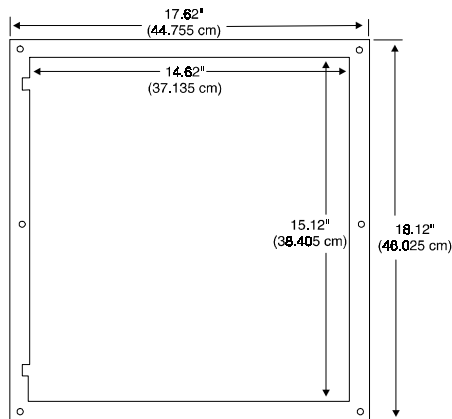
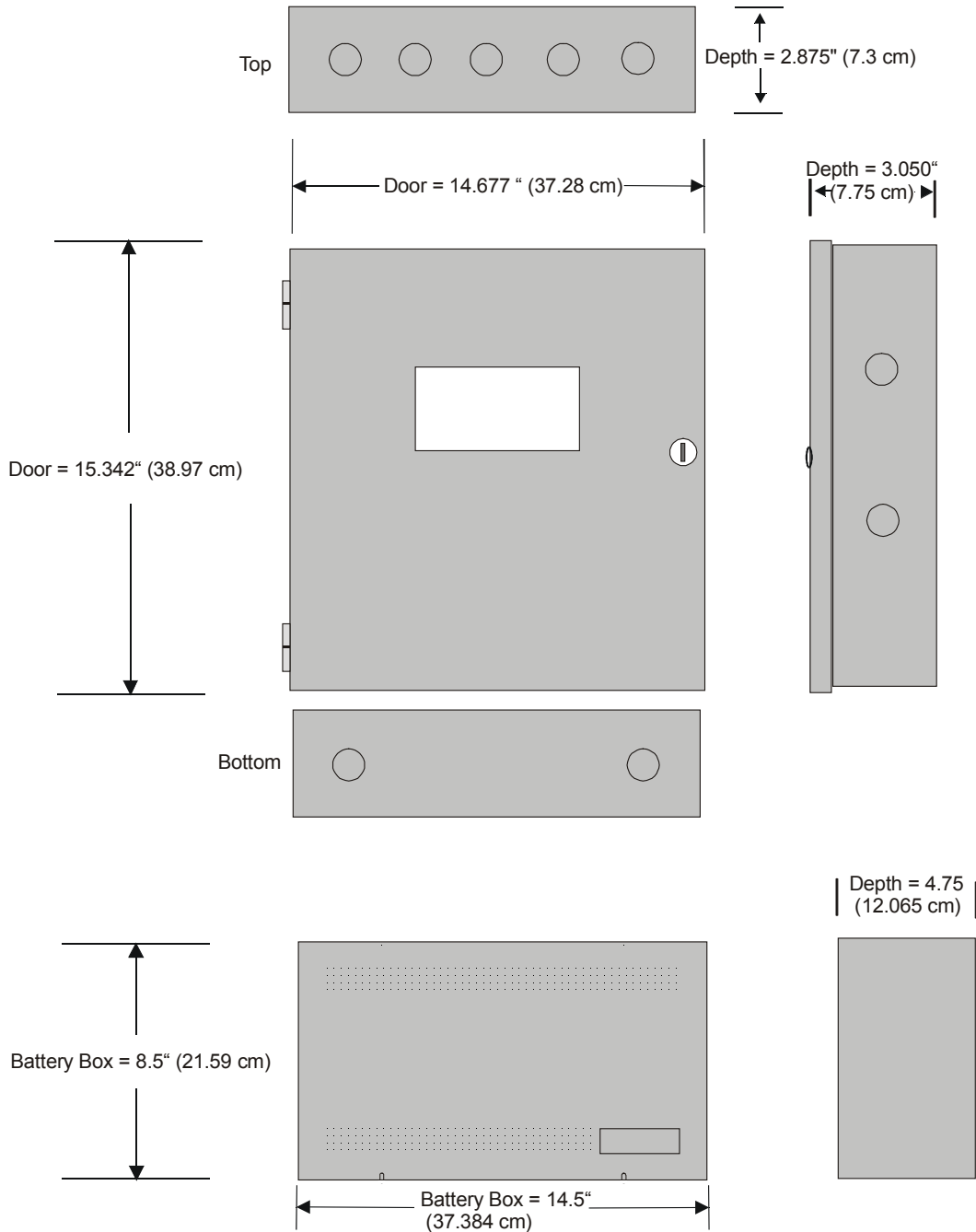

FIGURE 2-3: Backbox and Battery Box



Notes:

1. Mount the Fire Alarm Control Communicator cabinet to the wall
2. Remove knockouts on bottom of FACP cabinet and top of BB-17F
3. Using conduit, hang the BB-17F from the Fire Alarm Control Communicator cabinet, making sure there is at least 1/2" of clearance between the two cabinets
4. Anchor the BB-17F to the wall

2.3 Operating Power



CAUTION: Several different sources of power can be connected to this panel. Disconnect all sources of power before servicing. The panel and associated equipment may be damaged by removing and/or inserting cards, modules or interconnecting cables while this unit is energized.

Primary Power Source (AC) and Earth Ground Connections

AC power connections are made inside the control panel cabinet. The primary power source for the MS-5024UD is 120 VAC, 60 Hz, 2.3 amps and for the MS-5024UDE is 220/240 VAC, 50 HZ, 1.2 amps. Run a pair of wires (with ground conductor) from the protected premises main breaker box to TB1 of the main circuit board. As per the National Electric Code, use 14 AWG (2.00 mm²) or heavier gauge wire with 600V insulation. No other equipment may be connected to this circuit. In addition, this circuit must be provided with overcurrent protection and may not contain any power disconnect devices. A separate Earth Ground connection must be made to ensure proper panel operation and lightning and transient protection. Connect the Earth Ground wire [minimum 14 AWG (2.00 mm²)] to one of the transformer mounting studs. *Note: Do not use conduit for the Earth Ground connection since this does not provide reliable protection.*

Secondary Power Source (Batteries)

Observe polarity when connecting the battery. Connect the battery cable to J1 on the main circuit board using the plug-in connector provided. The battery charger is current-limited and capable of recharging sealed lead acid type batteries. The charger shuts off when the system is in alarm or if the battery voltage drops too low (below 17.4 VDC). See Appendix A for calculation of the correct battery rating.



CAUTION: Battery contains sulfuric acid which can cause severe burns to the skin and eyes, and can destroy fabrics. If contact is made with sulfuric acid, immediately flush the skin or eyes with water for 15 minutes and seek immediate medical attention.

FIGURE 2-4: Operating Power Connections

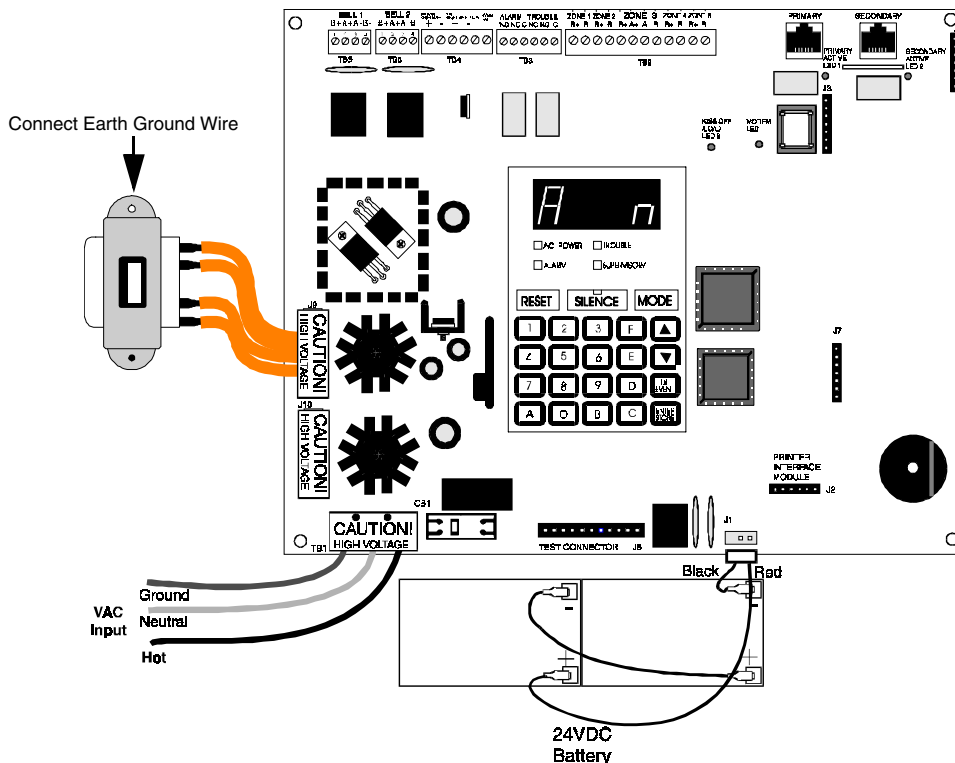

2.4 Input Circuits

The control panel has five zone input circuits. The maximum loop resistance limit for each is 100 ohms. All field wiring of each zone is supervised for opens and ground faults. Both conditions are visually and audibly annunciated as well as communicated to a Central Station.

Each zone is a Style B Initiating Device Circuit (IDC) designed to accept any normally open contact device and conventional 2-wire, 24 volt smoke detectors. Each zone is power-limited to 7.26 mA in standby and 42 mA in alarm. Zone 3 may also be configured as a Style D Initiating Device Circuit.

Note: All five initiating zones may be converted to Style D (Class A) by using a CAC-5F Class A Converter module. Refer to Figure 2-17, "CAC-5F Style D Converter," on page 32.

Zones 1-5 may be programmed as listed below. The factory default is 2-wire smoke detector for all zones:

- 2-wire smoke detector (factory default)
- Pull station
- Normally open contact device(s)
- Supervisory
- Supervisory, autoresettable

Zone 3 may also be programmed as:

- Waterflow, silenceable
- Waterflow, nonsilenceable

Note: A maximum of five waterflow devices may be used on zone 3 per NFPA 72.

Four-wire smoke detectors may be connected to any zone. Resettable power is provided via TB4, Terminals 3 and 4.

It is allowable to mix an assortment of device types (i.e. smoke detectors, heat detectors, pull stations, etc.) on any zone. This is not recommended, however, since specific and detailed reports will not be possible. For example, the report of general fire alarm versus pull station fire alarm or smoke detector fire alarm.

Refer to the Fire•Lite Device Compatibility Document for a list of compatible smoke detectors.

FIGURE 2-5: Typical Initiating Device Circuit Connections

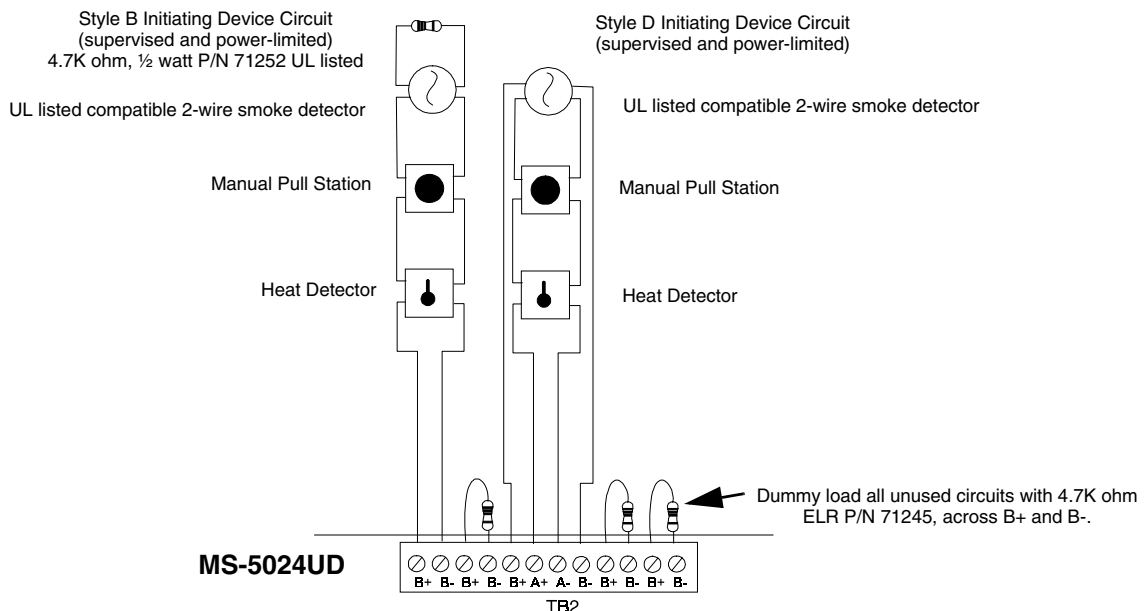

2.5 Output Circuits

DC Power Output Connections

All DC power outputs are power-limited.

FIGURE 2-6: Auxiliary Power Connections

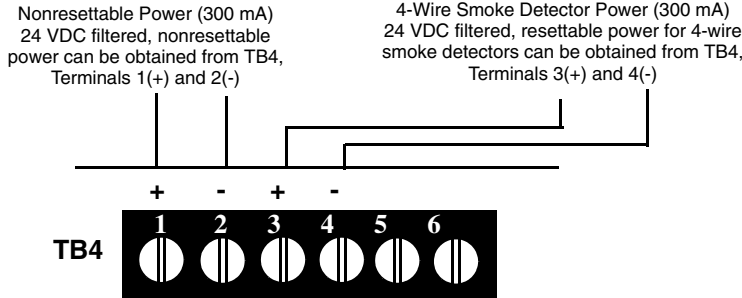

Telephone Circuits

Provision to connect to two independent telephone lines is available via two telephone jacks labeled PH1 (primary) and PH2 (secondary). Telephone line control/command is possible via double line seizure as well as usage of an RJ31X style interconnection. Refer to Figure 2-10, “Wiring Phone Jacks,” on page 27.

Notification Appliance Circuits

The MS-5024UD provides two NACs (Notification Appliance Circuits) which can be configured as Style Y or Style Z. Each circuit is capable of 2.5 amps of current. Total current drawn from these as well as other DC power outputs cannot exceed 3.6 amps with the standard transformer, 5.6 amps if an optional XRM-24 transformer (XRM-24E for the MS-5024UDE) is installed. Circuits are supervised and power-limited. Refer to the Fire•Lite Device Compatibility Document for a listing of compatible notification appliances.

FIGURE 2-7: Notification Appliance Circuit Connections

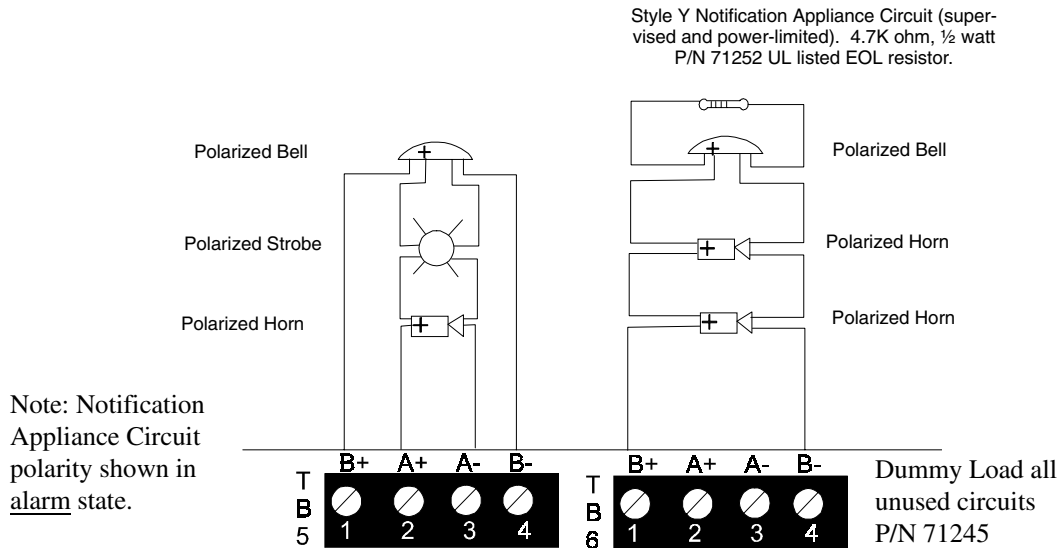

Both Notification Appliance Circuits may be programmed as follows:

- Silenceable
- Nonsilenceable
- Enabled/disabled
- Silence inhibited
- Autosilence, 5 to 30 minutes
- Coded (March Time, Temporal or California)

Output Circuits

Standard Relays

The control panel provides a set of Form-C alarm and a set of Form-C trouble contacts rated for 2.0 amps @ 30VDC (resistive).

Relay Drivers

Relay driver outputs are provided for supervisory and communicator failure. These outputs can be used to drive UL 864 listed remote relays such as the MR-101C and MR-201C.

The control panel's open collector outputs on TB4, terminals 5 and 6 can be used to activate UL 864 listed relays. Outputs are rated for 40 mA. The normal condition for each output is as shown below:

TB4-5 Supervisory	Off (deenergized)
TB4-6 Communications Failure	Off (deenergized)

Relays must be placed inside the cabinet or in a UL 864 recognized enclosure. Wiring from the control panel's terminals on TB4 to the relays must be less than 3 feet in length and enclosed in conduit. Wiring from the relay outputs must remain in the same room as the location of the enclosure and be enclosed in conduit.

FIGURE 2-8: Auxiliary Relay and Relay Driver Terminals

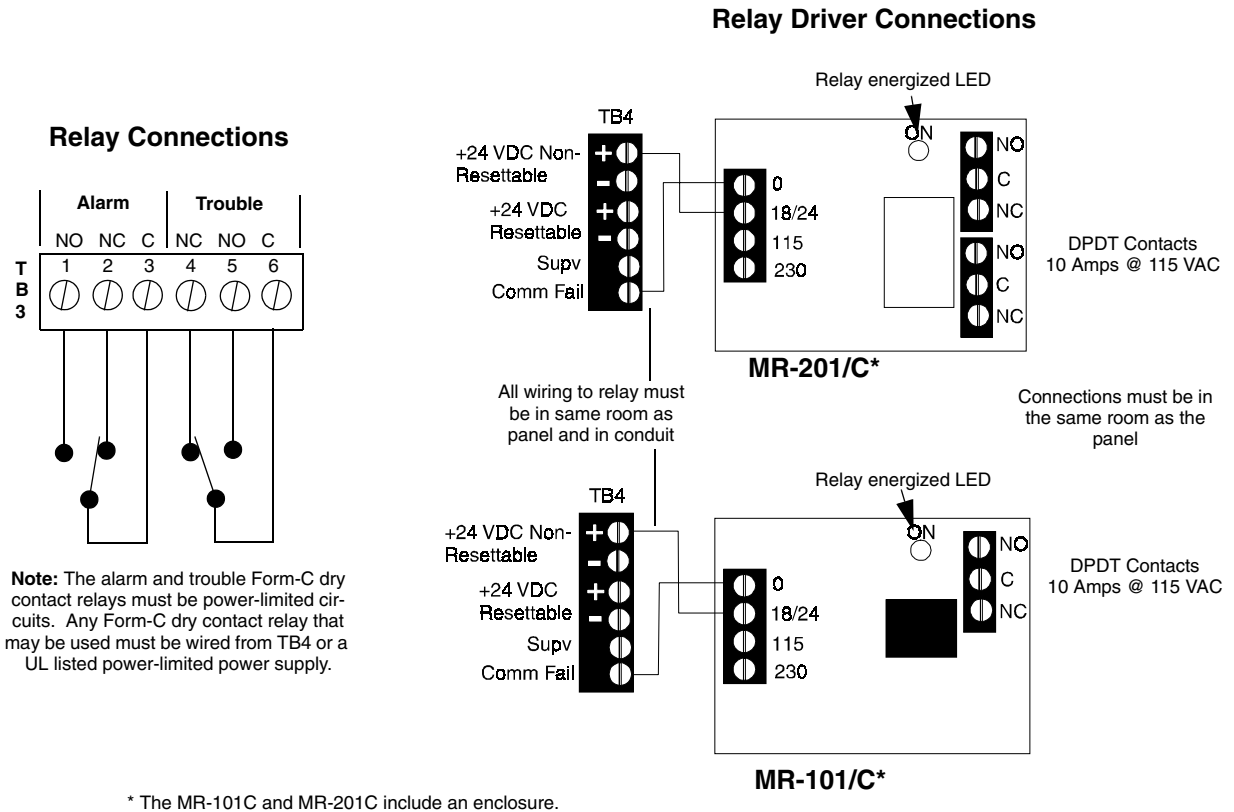

2.6 UL Power-limited Wiring Requirements

Power-limited and nonpower-limited circuit wiring must remain separated in the cabinet. All power-limited circuit wiring must remain at least 0.25" (6.35 mm) away from any nonpower-limited circuit wiring. Furthermore, all power-limited and nonpower-limited circuit wiring must enter and exit the cabinet through different knockouts and/or conduits. A typical wiring diagram for the MS-5024UD is shown below. Refer to Figure 2-16, "RM-5F Installation and Wiring," on page 31 for additional information on wiring the RM-5F Relay module.

FIGURE 2-9: Typical Wiring Diagram for UL Power-limited Requirements

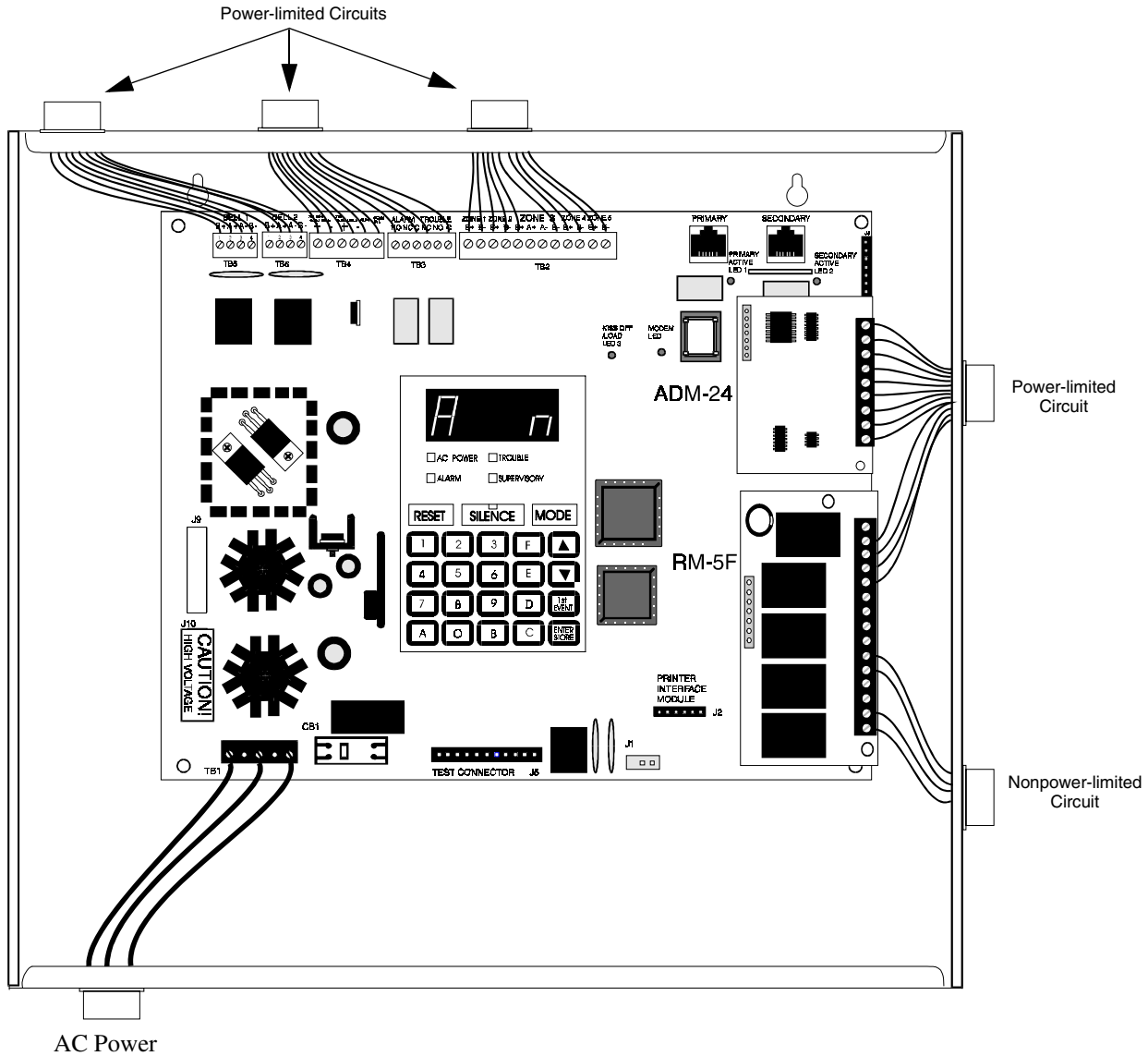

2.7 Digital Communicator

Two independent telephone lines can be connected to the control panel. Telephone line control/command is made possible via double line seizure as well as usage of an RJ31X style interconnection. Note that it is critical that the panel's digital communicator be located as the first device on the incoming telephone circuit to properly function.

The control panel's digital communicator is built into the main circuit board. Connection and wiring of two phone lines is required as shown below.

FIGURE 2-10:Wiring Phone Jacks

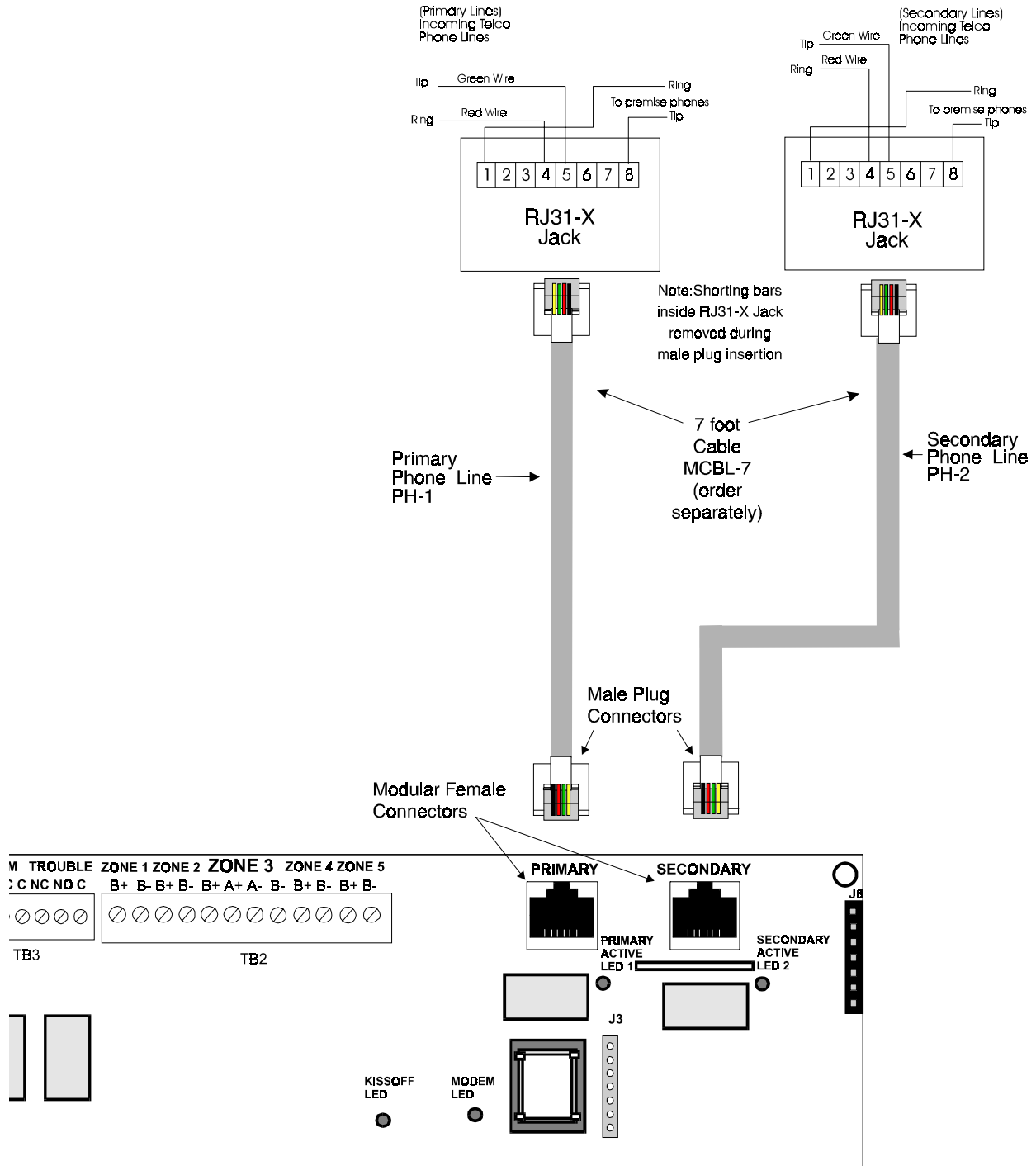

2.8 Optional Boards

2.8.1 ADM-24 Annunciator Driver Module

The Annunciator Driver Module supports the RZA-5F Remote Annunciator. Annunciator wiring is supervised for open conditions by this module. The Annunciator Driver Module mounts to J3 in the upper right corner of the main circuit board.

FIGURE 2-11:ADM-24 Annunciator Driver Module

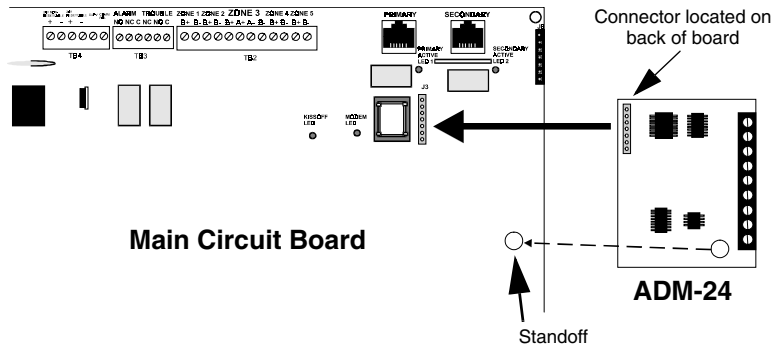

2.8.2 RZA-5F Remote Annunciator

The RZA-5F mounts on a standard single-gang electrical box and provides LED indication of the following:

- Alarm Zone 1 (red)
- Alarm Zone 2 (red)
- Alarm Zone 3 (red)
- Alarm Zone 4 (red)
- Alarm Zone 5 (red)
- System Trouble (yellow)

The remote annunciator provides individual zone alarm LEDs, a system trouble LED, a local piezo sounder and a remote sounder shut off switch. All LEDs and their wiring are supervised for open conditions. Any open condition will cause the System Trouble LED to turn on.

Note: The Remote Annunciator requires the use of an ADM-24 Annunciator Driver Module.

FIGURE 2-12:RZA-5F

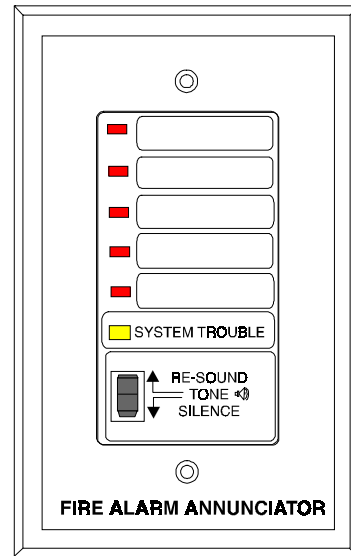

FIGURE 2-13:Wiring the RZA-5F/ADM-24

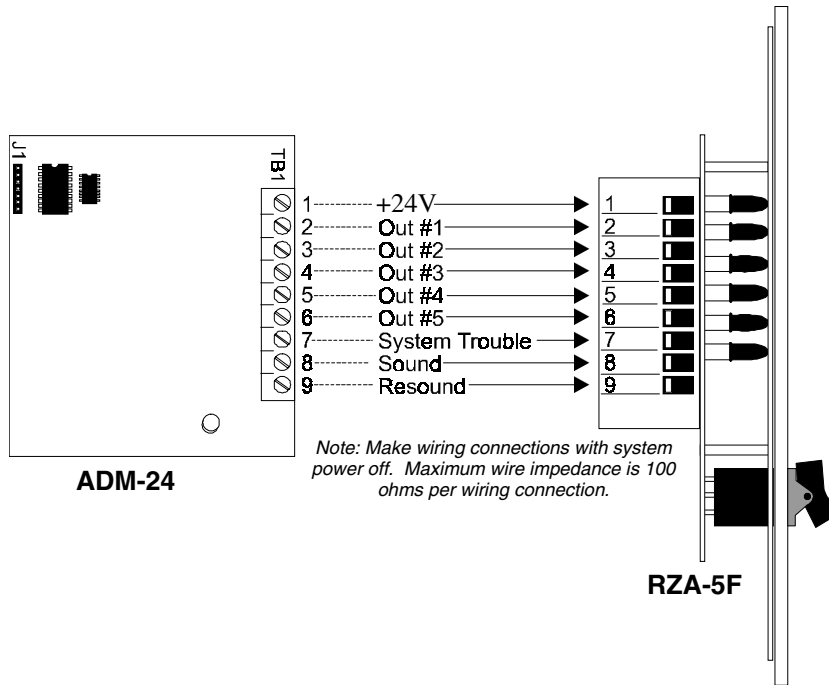
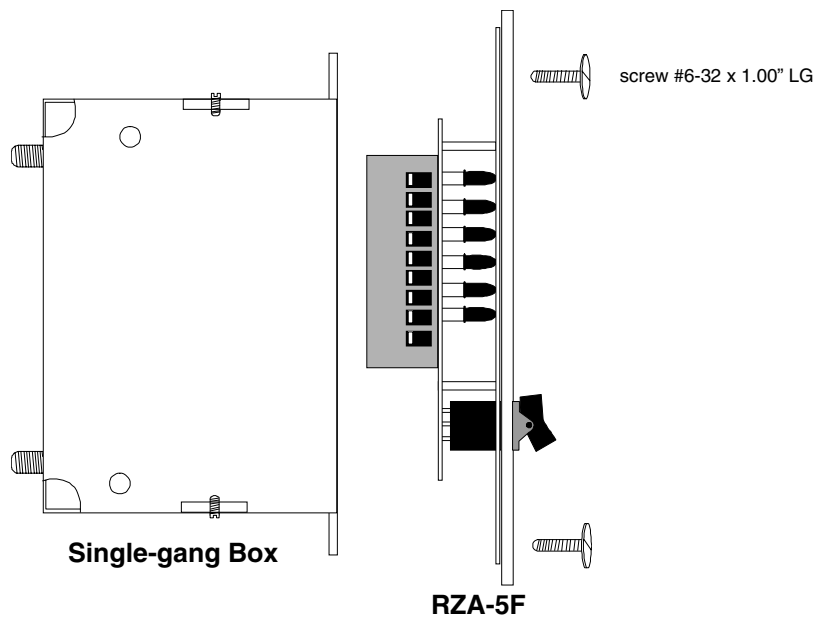

FIGURE 2-14:Installing the Annunciator (Single-Gang Electrical Box)



2.8.3 PRT-24 Printer Interface Module

A remote printer may be permanently or temporarily connected to provide a hardcopy printout of normal current system status and activity, program entries, history file, troubleshoot mode voltages and walktest data. The PRT-24 provides an EIA-232 conversion to adapt to most 40 and 80 column printers.



CAUTION: DO NOT connect a printer to the Fire Alarm Control Communicator if a ground fault exists on the panel. Circuit damage may result.

Installation

Remote printers require separate external primary power. Also required is the PRT-24 which includes the Printer Interface Module and a 6 foot interface cable prewired to a DB25 connector. Connect the interface cable to the PRT-24 as shown in Figure 2-15. Insert the two supplied standoffs into mounting holes near the J2 connector on the main circuit board. Connect the Printer Interface board to J2 on the main circuit board, press onto standoffs and connect the attached cable to the serial EIA-232 port on the printer. The printer may be placed a maximum of 50 feet from the panel. Note that a ground fault may occur on the control panel when this connection is made. For this reason, it is important that there be no preexisting ground fault on the panel. *For permanent printer connection, a ground fault is not allowed.*

Printer Configuration

The PRT-24 is required. Also refer to the documentation supplied with your printer. Set the printer's options as listed in the table below.

FIGURE 2-15: Remote Printer Connections

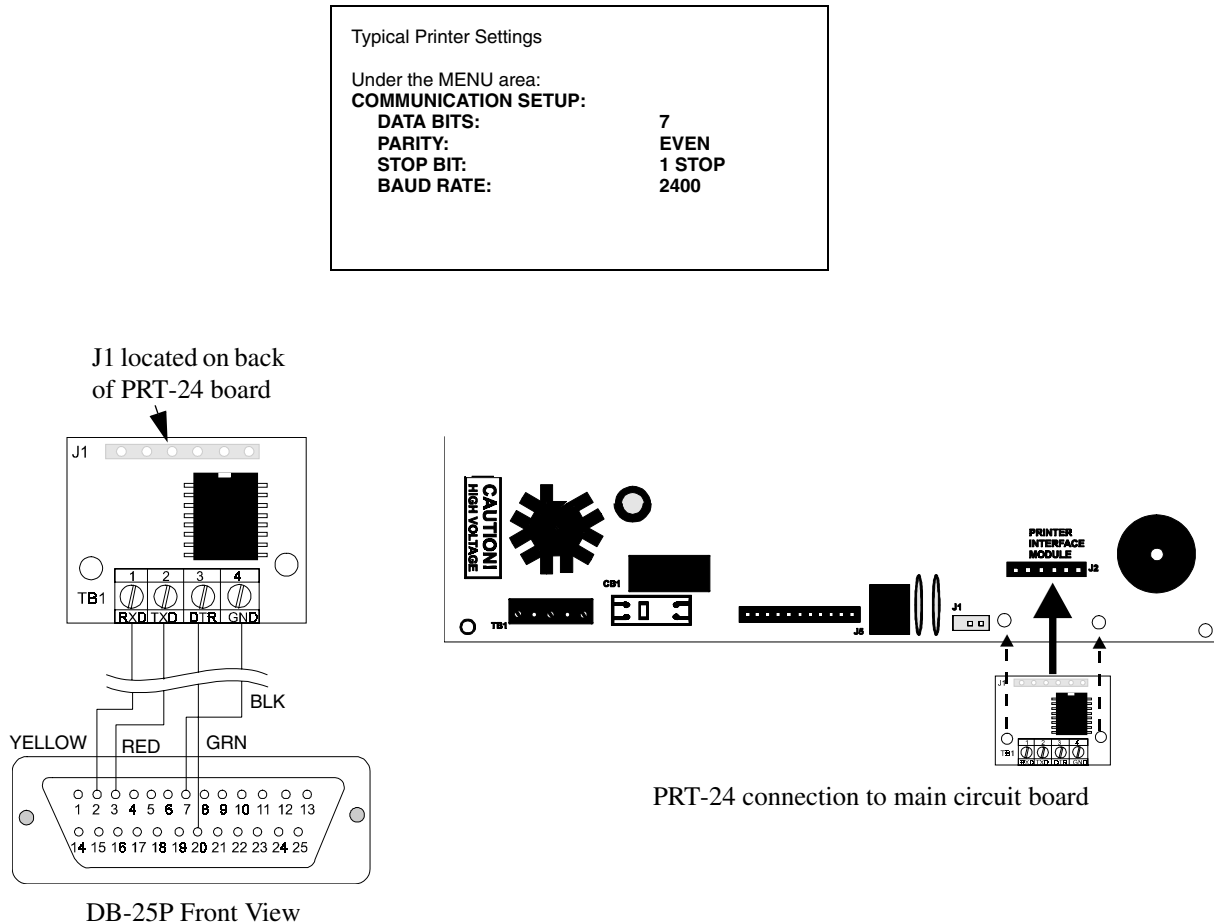

2.8.4 RM-5F Five-Zone Relay Module

The RM-5F option module provides five Form-C relays which track zones 1 through 5. The module mounts to connector J7 on the lower right side of the main circuit board as illustrated in Figure 2-16.

Nonpower-limited and power-limited wiring must have a minimum distance of 0.25" (6.35 mm) wire to wire. If this module is used to drive nonpower-limited and power-limited circuits:

1. Skip a set of dry contacts to maintain the 0.25" (6.35mm) required space between power-limited and non-power-limited circuits. The wiring of this module must follow the requirements as specified above - **OR**
2. If this module is needed to drive power-limited and nonpower-limited relays that are next to each other, one relay must be used as an open circuit and the other as a closed circuit as shown in Figure 2-16.

FIGURE 2-16:RM-5F Installation and Wiring

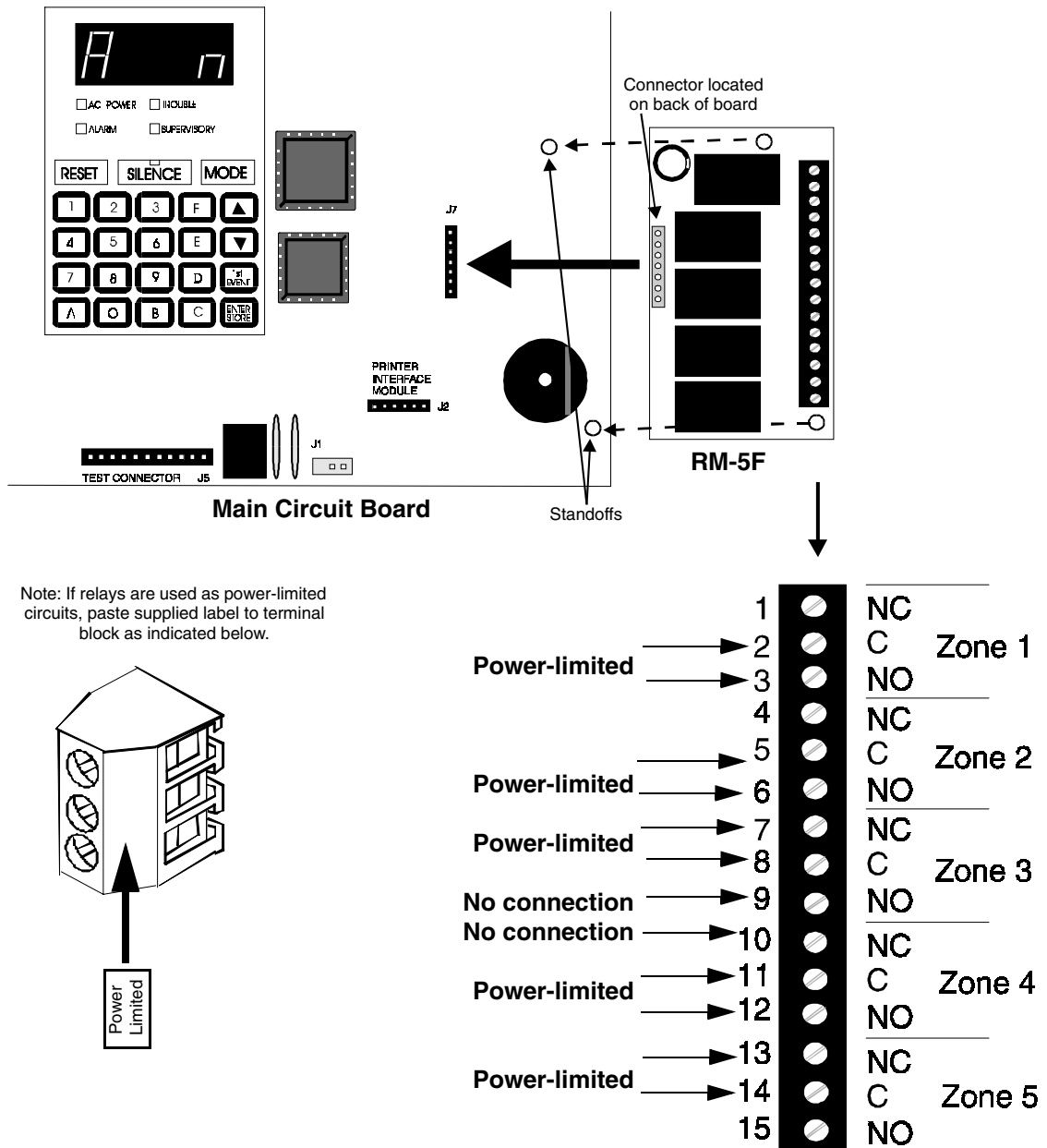

Note: Zone Relay Contact Ratings - Maximum Switched Power is 150 watts or 1250 VA. Maximum Switched Current is 5 Amps
UL Rating: 5 Amps @ 30 VDC or 125 VAC, resistive. Contact Material: Silver Alloy

2.8.5 CAC-5F Class A Converter Module

The CAC-5F module converts the Style B (Class B) Initiating Device Circuits to Style D (Class A). The CAC-5F mounts to terminal block TB2 located in the upper center of the main circuit board. Refer to Figure 2-17, “CAC-5F Style D Converter,” on page 32. The removable terminal block on the CAC-5F module provides for ease of wiring.

FIGURE 2-17: CAC-5F Style D Converter

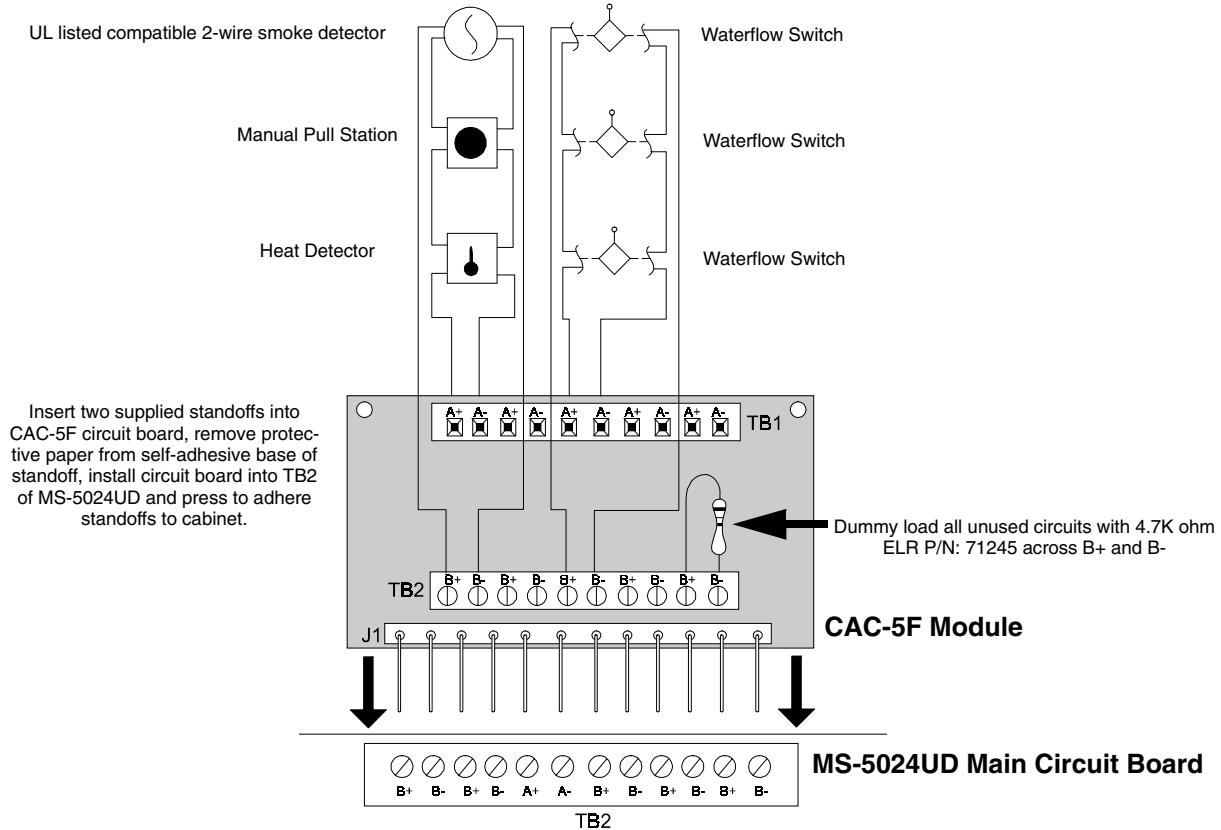

Notes:

1. Circuits 1 through 5 can accommodate 2-wire smoke detectors, plus any normally open contact device such as heat detectors or manual pull stations.
2. Only circuit 3 accommodates the nonsilenceable waterflow function.

CHAPTER 3 *Programming Instructions*

This chapter describes programming the panel from the onboard keyboard. Chapter 7 describes remote site upload/download which includes programming the control panel on premises. Programming of the control panel is possible at any time except when an alarm condition is present or during a fire drill.

The control panel has been designed for many different types of applications. After examining your specific application, review the programming options and choose the entries best suited for your system.

The control panel has a built-in intelligent programmer. All programming selections are stored in nonvolatile Electrically Erasable Programmable Read-Only Memory (EEPROM). This ensures that the control panel will remember all entries made in programming mode even if both AC and battery power are removed. Invalid entries cause a 'beep' from the onboard piezo sounder.

The user **must** program the primary and secondary phone numbers, account numbers and 24 hour test report times for each Central Station account and the current time and date. The control panel comes with factory chosen options/features already programmed. Other options/features may be programmed if desired. If all factory default settings are acceptable, programming is complete.

3.1 Entering Program Mode

To enter the Program Mode, press the **MODE** key once, (the display will go blank). You then have ten seconds to start entering the Program Mode code **7764**.

☛ **7764** spells PROG on a Touch-Tone® phone.

If an incorrect key is entered, reenter the proper 4-digit code *before* pressing the **[ENTER/STORE]** key. Note that as information is entered into the control panel, the digits will scroll across the display from right to left:

```

__7
_77
_776
7764
    
```

A pause of up to 10 seconds is allowed between each number while entering the code. After pressing the **[ENTER/STORE]** key, the control panel will be in Program Mode and display **00_F**. A maximum of 10 minutes of idle time is allowed at this point before starting program entries, otherwise, the control panel will return to Normal Mode. A maximum of 10 minutes is allowed between any key stroke. All entries made prior to the 10 minute time-out are valid and will be stored.

Once in Program Mode, the control panel will:

- Blink the trouble LED
- Activate the trouble relay
- Disable the NACs (Notification Appliance Circuits)
- Disable the alarm relay
- Display **00_F**
- Ignore all other keys other than those mentioned in this section
- Continue to communicate any events not previously acknowledged at a Central Station prior to entering Program Mode

Switch Functions

Note that address location 56 is factory defaulted to '0' for 'control panel only.' This keeps the communicator off until location 56 is changed to '1' for 'slave communicator' or '2' for 'panel/communicator.' Once location 56 is set to '1' or '2' and a valid phone number is entered, entry into the Program Mode will cause transmission of the 'system off normal' report.

When viewing any address in Program Mode, the first three digits on the left of the display represent the memory address which can be 00 to 374 (alpha-characters are not used). The last digit, farthest right, represents the contents of the memory address. The first address and contents displayed upon entering Program Mode are shown below:

00_F
(address)(data)

3.2 Switch Functions

The function of each keypad key in Program Mode is shown below.

FIGURE 3-1: Control Panel Keypad

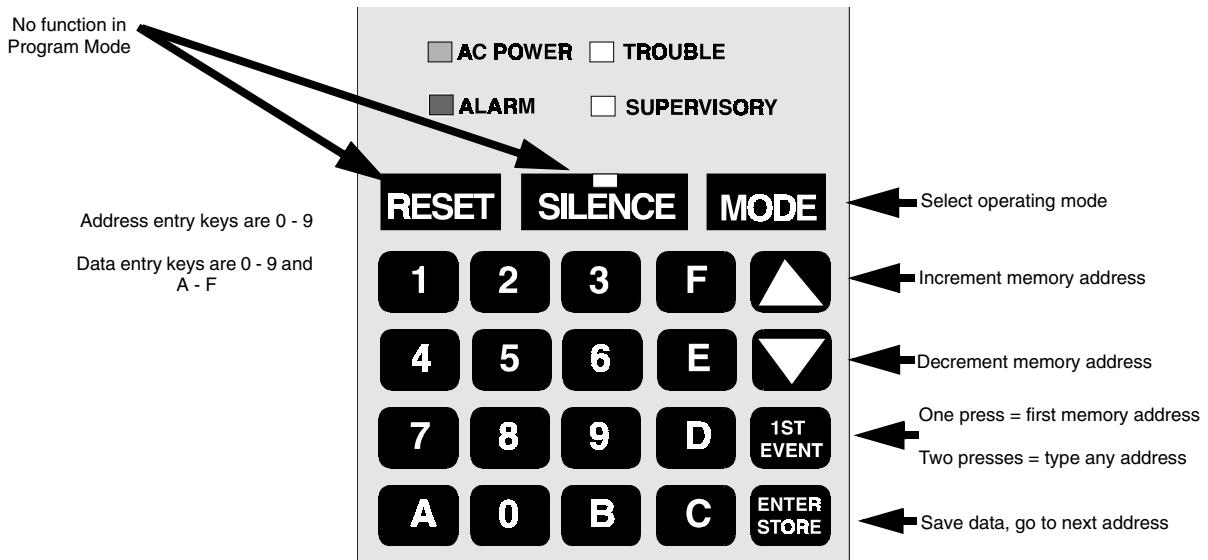

3.3 Programming Options

Primary Central Station Phone Number (00-15)

The first sixteen addresses (00-15) are factory set to 'F' (00_F to 15_F). Programming this feature is typically done as follows: If the phone number to be entered is 484-7161, press 4. The display will read 00_4. Press [ENTER/STORE] to save the entry to memory and increment to the next address 01_F.

Enter the remaining numbers in their respective addresses as shown below:

Phone Number	4	8	4	7	1	6	1	F	F	F	F	F	F	F	F	
Addresses	00	01	02	03	04	05	06	07	08	09	10	11	12	13	14	15

Programming Options

Valid entries for both the primary and secondary phone numbers are 0 - F with the numeric digits as dialed numbers and the alpha-characters representing the following functions:

- A = * on a Touchtone phone keypad
- B = # on a Touchtone phone keypad
- C = look for secondary dial tone for up to two seconds (then dial anyway)
- D = 3-second pause
- E = 5-second pause
- F = end of phone number (Note: F must be entered)

Primary Central Station Number Communication Format (16)

One location is needed to select the Communication Format for the primary phone number. Address 16 is used for this purpose. The default (factory setting) for this address is 'E' for Ademco Contact ID format. '0' through 'E' may be entered in place of the default entry. After making the selection, press the [ENTER/STORE] key to store the selection. The available format options are as follows:

- 0: 4+1 Ademco Express Standard, DTMF, 1400/2300 ACK
- 1: 4+2 Ademco Express Standard, DTMF, 1400/2300 ACK
- 2: 3+1 Standard 1800 Hz Carrier, 2300 Hz ACK
- 3: 3+1 Expanded 1800 Hz Carrier, 2300 Hz ACK
- 4: 3+1 Standard 1900 Hz Carrier, 1400 Hz ACK
- 5: 3+1 Expanded 1900 Hz Carrier, 1400 Hz ACK
- 6: 4+1 Standard 1800 Hz Carrier, 2300 Hz ACK
- 7: 4+1 Expanded 1800 Hz Carrier, 2300 Hz ACK
- 8: 4+1 Standard 1900 Hz Carrier, 1400 Hz ACK
- 9: 4+1 Expanded 1900 Hz Carrier, 1400 Hz ACK
- A: 4+2 Standard 1800 Hz Carrier, 2300 Hz ACK
- B: 4+2 Expanded 1800 Hz Carrier, 2300 Hz ACK
- C: 4+2 Standard 1900 Hz Carrier, 1400 Hz ACK
- D: 4+2 Expanded 1900 Hz Carrier, 1400 Hz ACK
- E: Ademco Contact ID, DTMF, 1400/2300 ACK
- F: Not Used

Note: Consult your Central Station for proper selection or consult our factory representatives. For any format chosen, the control panel automatically programs all of the event codes. Refer to Table 3-1 through Table 3-5.

Programming Options

3+1, 4+1 Express, 4+1 Standard and Expanded & 4+2 Expanded Formats

If '0, 2, 3, 4, 5, 6, 7, 8, 9, B or D' is entered for address 16, the following data is automatically programmed for the Primary Central Station phone number event codes. Enter '0' for the Setting to disable the report.

TABLE 3-1: Primary Event Codes - 3+1, 4+1 Express, 4+1 Standard, Expanded & 4+2 Expanded

<u>Address</u>	<u>Description</u>	<u>Setting</u>
127	Primary # Zone 1 Alarm Code	1
128	Primary # Zone 2 Alarm Code	1
129	Primary # Zone 3 Alarm Code	1
130	Primary # Zone 4 Alarm Code	1
131	Primary # Zone 5 Alarm Code	1
132	Primary # Zone 1 Disable Code	F
133	Primary # Zone 2 Disable Code	F
134	Primary # Zone 3 Disable Code	F
135	Primary # Zone 4 Disable Code	F
136	Primary # Zone 5 Disable Code	F
137	Primary # Drill Code	9
138	Primary # AC Fault Code	F
139	Primary # Zone 1 Fault Code	F
140	Primary # Zone 2 Fault Code	F
141	Primary # Zone 3 Fault Code	F
142	Primary # Zone 4 Fault Code	F
143	Primary # Zone 5 Fault Code	F
144	Primary # Earth Fault Code	F
145	Primary # Low Battery Fault Code	F
146	Primary # No Battery Fault Code	F
147	Primary # Telco Primary Line Fault Code	F
148	Primary # Telco Secondary Line Fault Code	F
149	Primary # NAC #1 Fault Code	F
150	Primary # NAC #2 Fault Code	F
151	Primary # Communication Trouble Primary # Code	F
152	Primary # Communication Trouble Secondary # Code	F
153	Primary # Annunciator Fault Code	F
154	Primary # System Off Normal Code	F
155	Primary # Zone 1 Alarm Restore Code	E
156	Primary # Zone 2 Alarm Restore Code	E
157	Primary # Zone 3 Alarm Restore Code	E
158	Primary # Zone 4 Alarm Restore Code	E
159	Primary # Zone 5 Alarm Restore Code	E
160	Primary # Zone 1 Disable Restore Code	E
161	Primary # Zone 2 Disable Restore Code	E
162	Primary # Zone 3 Disable Restore Code	E
163	Primary # Zone 4 Disable Restore Code	E
164	Primary # Zone 5 Disable Restore Code	E
165	Primary # Drill Restore Code	9
166	Primary # AC Fault Restore Code	E
167	Primary # Zone 1 Fault Restore Code	E
168	Primary # Zone 2 Fault Restore Code	E
169	Primary # Zone 3 Fault Restore Code	E
170	Primary # Zone 4 Fault Restore Code	E
171	Primary # Zone 5 Fault Restore Code	E
172	Primary # Earth Fault Restore Code	E
173	Primary # Low Battery Fault Restore Code	E
174	Primary # No Battery Fault Restore Code	E
175	Primary # Telco Primary Line Fault Restore Code	E
176	Primary # Telco Secondary Line Fault Restore Code	E
177	Primary # NAC # 1 Fault Restore Code	E
178	Primary # NAC # 2 Fault Restore Code	E
179	Primary # Communication Trouble Primary # Restore Code	E
180	Primary # Communication Trouble Secondary # Restore Code	E
181	Primary # Annunciator Fault Restore Code	E
182	Primary # System Off Normal Restore Code	E
183	Primary # System Test Report	9
184	Primary # System Abnormal Test Report	F
185	Primary # Request for Upload/Download	7
186	Primary # Successful Upload	7
187	Primary # Successful Download	7
188	Primary # Failed Upload/Download	7

Programming Options

4+2 Standard and 4+2 Express Formats

If '1, A or C' is entered for address 16, the following data is automatically programmed for the Primary Central Station phone number event codes. Enter '00' for the Setting to disable the report.

TABLE 3-2: Primary Event Codes - 4+2 Standard and 4+2 Express

<u>Address</u>	<u>Description</u>	<u>Setting</u>
127 - 128	Primary # Zone 1 Alarm Code	I1
129 - 130	Primary # Zone 2 Alarm Code	I2
131 - 132	Primary # Zone 3 Alarm Code	I3
133 - 134	Primary # Zone 4 Alarm Code	I4
135 - 136	Primary # Zone 5 Alarm Code	I5
137 - 138	Primary # Zone 1 Disable Code	F1
139 - 140	Primary # Zone 2 Disable Code	F2
141 - 142	Primary # Zone 3 Disable Code	F3
143 - 144	Primary # Zone 4 Disable Code	F4
145 - 146	Primary # Zone 5 Disable Code	F5
147 - 148	Primary # Drill Code	97
149 - 150	Primary # AC Fault Code	F6
151 - 152	Primary # Zone 1 Fault Code	F1
153 - 154	Primary # Zone 2 Fault Code	F2
155 - 156	Primary # Zone 3 Fault Code	F3
157 - 158	Primary # Zone 4 Fault Code	F4
159 - 160	Primary # Zone 5 Fault Code	F5
161 - 162	Primary # Earth Fault Code	F7
163 - 164	Primary # Low Battery Fault Code	F8
165 - 166	Primary # No Battery Fault Code	F9
167 - 168	Primary # Telco Primary Line Fault Code	FA
169 - 170	Primary # Telco Secondary Line Fault Code	FB
171 - 172	Primary # NAC #1 Fault Code	FC
173 - 174	Primary # NAC #2 Fault Code	FC
175 - 176	Primary # Communication Trouble Primary # Code	FD
177 - 178	Primary # Communication Trouble Secondary # Code	FE
179 - 180	Primary # Annunciator Fault Code	FC
181 - 182	Primary # System Off Normal Code	FF
183 - 184	Primary # Zone 1 Alarm Restore Code	E1
185 - 186	Primary # Zone 2 Alarm Restore Code	E2
187 - 188	Primary # Zone 3 Alarm Restore Code	E3
189 - 190	Primary # Zone 4 Alarm Restore Code	E4
191 - 192	Primary # Zone 5 Alarm Restore Code	E5
193 - 194	Primary # Zone 1 Disable Restore Code	E1
195 - 196	Primary # Zone 2 Disable Restore Code	E2
197 - 198	Primary # Zone 3 Disable Restore Code	E3
199 - 200	Primary # Zone 4 Disable Restore Code	E4
201 - 202	Primary # Zone 5 Disable Restore Code	E5
203 - 204	Primary # Drill Restore Code	98
205 - 206	Primary # AC Fault Restore Code	E6
207 - 208	Primary # Zone 1 Fault Restore Code	E1
209 - 210	Primary # Zone 2 Fault Restore Code	E2
211 - 212	Primary # Zone 3 Fault Restore Code	E3
213 - 214	Primary # Zone 4 Fault Restore Code	E4
215 - 216	Primary # Zone 5 Fault Restore Code	E5
217 - 218	Primary # Earth Fault Restore Code	E7
219 - 220	Primary # Low Battery Fault Restore Code	E8
221 - 222	Primary # No Battery Fault Restore Code	E9
223 - 224	Primary # Telco Primary Line Fault Restore Code	EA
225 - 226	Primary # Telco Secondary Line Fault Restore Code	EB
227 - 228	Primary # NAC # 1 Fault Restore Code	EC
229 - 230	Primary # NAC # 2 Fault Restore Code	EC
231 - 232	Primary # Communication Trouble Primary # Restore Code	ED
233 - 234	Primary # Communication Trouble Secondary # Restore Code	EE
235 - 236	Primary # Annunciator Fault Restore Code	EC
237 - 238	Primary # System Off Normal Restore Code	EF
239 - 240	Primary # System Test Report	99
241 - 242	Primary # System Abnormal Test Report	91
243 - 244	Primary # Request for Upload/Download	71
245 - 246	Primary # Successful Upload	72
247 - 248	Primary # Successful Download	73
249 - 250	Primary # Failed Upload/Download	74

Ademco Contact ID Format

If 'E' is entered for address 16 in Program Mode Level 1, the data shown in Table 3-3 is automatically programmed for the Primary Central Station phone number event codes. Enter '000' for the setting to disable the report. The Setting entry is programmable, the Zone Number cannot be changed. Restoral code settings match the settings shown with the addition of an 'R' code transmitted. Refer to page 83 for additional information.

TABLE 3-3: Event Codes, Primary Central Station Number

<u>Address</u>	<u>Description</u>	<u>Setting</u>	<u>Zone No.</u>
127-129	Primary # Zone 1 Alarm Code	111	001
130-132	Primary # Zone 2 Alarm Code	111	002
133-135	Primary # Zone 3 Alarm Code	111	003
136-138	Primary # Zone 4 Alarm Code	111	004
139-141	Primary # Zone 5 Alarm Code	111	005
142-144	Primary # Zone 1 Disabled Code	570	001
145-147	Primary # Zone 2 Disabled Code	570	002
148-150	Primary # Zone 3 Disabled Code	570	003
151-153	Primary # Zone 4 Disabled Code	570	004
154-156	Primary # Zone 5 Disabled Code	570	005
157-159	Primary # Drill Code	604	000
160-162	Primary # AC Fault Code	301	000
163-165	Primary # Zone 1 Fault Code	380	001
166-168	Primary # Zone 2 Fault Code	380	002
169-171	Primary # Zone 3 Fault Code	380	003
172-174	Primary # Zone 4 Fault Code	380	004
175-177	Primary # Zone 5 Fault Code	380	005
178-180	Primary # Earth Fault Code	310	000
181-183	Primary # Low Battery Fault Code	302	000
184-186	Primary # No Battery Fault Code	311	000
187-189	Primary # Telco Primary Line Fault Code	351	000
190-192	Primary # Telco Secondary Line Fault Code	352	000
193-195	Primary # NAC #1 Fault Code	321	001
196-198	Primary # NAC #2 Fault Code	322	002
199-201	Primary # Comm Trouble Primary # Code	354	001
202-204	Primary # Comm Trouble Secondary # Code	354	002
205-207	Primary # Annunciator Fault Code	330	000
208-210	Primary # System Off Normal Code	308	000
211-213	Primary # System Test Message	602	000
214-216	Primary # System Abnormal Test Message	608	000
217-219	Primary # Upload/Download Request Code	411	000
220-222	Primary # Upload Successful Code	416	000
223-225	Primary # Download Successful Code	412	000
226-228	Primary # Upload/Download Failed Code	413	000

Programming Options

Primary Central Station Number Account Code (17-20)

A unique account code is provided by the Central Station. Four locations at addresses 17-20 (factory default settings of all '0s') are used to enter the account code. Valid entries are 0 to 9 and A to F. The number of digits entered must match the format selection. If programming '2, 3, 4 or 5' into address 16, enter the three digit account code supplied by the Central Station (location 20 is ignored). If programming '0, 1, 6, 7, 8, 9, A, B, C or D' into address 16, enter the four digit account code supplied by the Central Station.

Primary Central Station Number 24 Hour Test Time (21-24)

Use military time when entering the 24 hour 'test' time. The 24 hour test report to phone number 1 takes up four locations, from addresses 21-24. The default is '2345' (11:45 PM). The limits for each address location are as follows:

21 - enter 0-2

22 - enter 0-9

23 - enter 0-5

24 - enter 0-9

Do not use 'A-F'

Primary Central Station Number 24/12/8/6 Hour Test Time Interval (25)

The test report sent to the Primary phone number may be sent every 6, 8, 12 or 24 hours. If the message is to be sent every 24 hours, leave the factory default entry of '0'. If other test report times are needed, enter '1' for 12 hours, '2' for 8 hours or '3' for 6 hours.

Secondary Central Station Phone Number (26-41)

Addresses (26-41) are factory set to 'F' (**26_F** to **41_F**). Programming this feature is typically done as follows: If the phone number to be entered is 484-7161, press **4**. The display will read **26_4**. Press [ENTER/STORE] to save the entry to memory and increment to the next address **27_F**.

Enter the remaining numbers in their respective addresses as shown below:

Phone Number	4	8	4	7	1	6	1	F	F	F	F	F	F	F	F	
Addresses	26	27	28	29	30	31	32	33	34	35	36	37	38	39	40	41

Valid entries for both the primary and secondary phone numbers are 0 - F with the numeric digits as dialed numbers and the alpha-characters representing the following functions:

A = * on a Touchtone phone keypad

B = # on a Touchtone phone keypad

C = look for secondary dial tone for up to two seconds (then dial anyway)

D = 3-second pause

E = 5-second pause

F = end of phone number (Note: F must be entered)

Programming Options

Secondary Central Station Number Communication Format (42)

One location is needed to select the Communication Format for the secondary phone number. Address 42 is used for this purpose. The default (factory setting) for this address is 'E' for Ademco Contact ID format. Selections '0' through 'E' may be entered in place of the default entry. After making the selection, press the [ENTER/STORE] key to store the selection. The available format options are as follows:

- 0: 4+1 Ademco Express Standard, DTMF, 1400/2300 ACK
- 1: 4+2 Ademco Express Standard, DTMF, 1400/2300 ACK
- 2: 3+1 Standard 1800 Hz Carrier, 2300 Hz ACK
- 3: 3+1 Expanded 1800 Hz Carrier, 2300 Hz ACK
- 4: 3+1 Standard 1900 Hz Carrier, 1400 Hz ACK
- 5: 3+1 Expanded 1900 Hz Carrier, 1400 Hz ACK
- 6: 4+1 Standard 1800 Hz Carrier, 2300 Hz ACK
- 7: 4+1 Expanded 1800 Hz Carrier, 2300 Hz ACK
- 8: 4+1 Standard 1900 Hz Carrier, 1400 Hz ACK
- 9: 4+1 Expanded 1900 Hz Carrier, 1400 Hz ACK
- A: 4+2 Standard 1800 Hz Carrier, 2300 Hz ACK
- B: 4+2 Expanded 1800 Hz Carrier, 2300 Hz ACK
- C: 4+2 Standard 1900 Hz Carrier, 1400 Hz ACK
- D: 4+2 Expanded 1900 Hz Carrier, 1400 Hz ACK
- E: Ademco Contact ID, DTMF, 1400/2300 ACK
- F: Not Used

Note: Consult your Central Station for proper selection or consult our factory representatives. For any format chosen, the control panel automatically programs all of the event codes. Refer to Table 3-1 through Table 3-5.

Programming Options

3+1, 4+1 Express, 4+1 Standard and Expanded & 4+2 Expanded Formats

If '0, 2, 3, 4, 5, 6, 7, 8, 9, B or D' is entered for address 42, the following data is automatically programmed for the Secondary Central Station phone number event codes. Enter '0' for the Setting to disable the report.

TABLE 3-4: Secondary Event Codes-3+1, 4+1 Express, 4+1 Standard, Expanded & 4+2 Expanded

<u>Address</u>	<u>Description</u>	<u>Setting</u>
251	Secondary # Zone 1 Alarm Code	1
252	Secondary # Zone 2 Alarm Code	1
253	Secondary # Zone 3 Alarm Code	1
254	Secondary # Zone 4 Alarm Code	1
255	Secondary # Zone 5 Alarm Code	1
256	Secondary # Zone 1 Disable Code	F
257	Secondary # Zone 2 Disable Code	F
258	Secondary # Zone 3 Disable Code	F
259	Secondary # Zone 4 Disable Code	F
260	Secondary # Zone 5 Disable Code	F
261	Secondary # Drill Code	9
262	Secondary # AC Fault Code	F
263	Secondary # Zone 1 Fault Code	F
264	Secondary # Zone 2 Fault Code	F
265	Secondary # Zone 3 Fault Code	F
266	Secondary # Zone 4 Fault Code	F
267	Secondary # Zone 5 Fault Code	F
268	Secondary # Earth Fault Code	F
269	Secondary # Low Battery Fault Code	F
270	Secondary # No Battery Fault Code	F
271	Secondary # Telco Primary Line Fault Code	F
272	Secondary # Telco Secondary Line Fault Code	F
273	Secondary # NAC #1 Fault Code	F
274	Secondary # NAC #2 Fault Code	F
275	Secondary # Communication Trouble Primary # Code	F
276	Secondary # Communication Trouble Secondary # Code	F
277	Secondary # Annunciator Fault Code	F
278	Secondary # System Off Normal Code	F
279	Secondary # Zone 1 Alarm Restore Code	E
280	Secondary # Zone 2 Alarm Restore Code	E
281	Secondary # Zone 3 Alarm Restore Code	E
282	Secondary # Zone 4 Alarm Restore Code	E
283	Secondary # Zone 5 Alarm Restore Code	E
284	Secondary # Zone 1 Disable Restore Code	E
285	Secondary # Zone 2 Disable Restore Code	E
286	Secondary # Zone 3 Disable Restore Code	E
287	Secondary # Zone 4 Disable Restore Code	E
288	Secondary # Zone 5 Disable Restore Code	E
289	Secondary # Drill Restore Code	9
290	Secondary # AC Fault Restore Code	E
291	Secondary # Zone 1 Fault Restore Code	E
292	Secondary # Zone 2 Fault Restore Code	E
293	Secondary # Zone 3 Fault Restore Code	E
294	Secondary # Zone 4 Fault Restore Code	E
295	Secondary # Zone 5 Fault Restore Code	E
296	Secondary # Earth Fault Restore Code	E
297	Secondary # Low Battery Fault Restore Code	E
298	Secondary # No Battery Fault Restore Code	E
299	Secondary # Telco Primary Line Fault Restore Code	E
300	Secondary # Telco Secondary Line Fault Restore Code	E
301	Secondary # NAC # 1 Fault Restore Code	E
302	Secondary # NAC # 2 Fault Restore Code	E
303	Secondary # Communication Trouble Primary # Restore Code	E
304	Secondary # Communication Trouble Secondary # Restore Code	E
305	Secondary # Annunciator Fault Restore Code	E
306	Secondary # System Off Normal Restore Code	E
307	Secondary # System Test Report	9
308	Secondary # System Abnormal Test Report	F
309	Secondary # Request for Upload/Download	7
310	Secondary # Successful Upload	7
311	Secondary # Successful Download	7
312	Secondary # Failed Upload/Download	7

Programming Options

4+2 Standard and 4+2 Express Formats

If '1, A or C' is entered for address 42, the following data is automatically programmed for the Secondary Central Station phone number event codes. Enter '00' for the Setting to disable the report.

TABLE 3-5: Secondary Event Codes - 4+2 Standard and 4+2 Express

<u>Address</u>	<u>Description</u>	<u>Setting</u>
251 - 252	Secondary # Zone 1 Alarm Code	I1
253 - 254	Secondary # Zone 2 Alarm Code	I2
255 - 256	Secondary # Zone 3 Alarm Code	I3
257 - 258	Secondary # Zone 4 Alarm Code	I4
259 - 260	Secondary # Zone 5 Alarm Code	I5
261 - 262	Secondary # Zone 1 Disable Code	F1
263 - 264	Secondary # Zone 2 Disable Code	F2
265 - 266	Secondary # Zone 3 Disable Code	F3
267 - 268	Secondary # Zone 4 Disable Code	F4
269 - 270	Secondary # Zone 5 Disable Code	F5
271 - 272	Secondary # Drill Code	97
273 - 274	Secondary # AC Fault Code	F6
275 - 276	Secondary # Zone 1 Fault Code	F1
277 - 278	Secondary # Zone 2 Fault Code	F2
279 - 280	Secondary # Zone 3 Fault Code	F3
281 - 282	Secondary # Zone 4 Fault Code	F4
283 - 284	Secondary # Zone 5 Fault Code	F5
285 - 286	Secondary # Earth Fault Code	F7
287 - 288	Secondary # Low Battery Fault Code	F8
289 - 290	Secondary # No Battery Fault Code	F9
291 - 292	Secondary # Telco Primary Line Fault Code	FA
293 - 294	Secondary # Telco Secondary Line Fault Code	FB
295 - 296	Secondary # NAC #1 Fault Code	FC
297 - 298	Secondary # NAC #2 Fault Code	FC
299 - 300	Secondary # Communication Trouble Primary # Code	FD
301 - 302	Secondary # Communication Trouble Secondary # Code	FE
303 - 304	Secondary # Annunciator Fault Code	FC
305 - 306	Secondary # System Off Normal Code	FF
307 - 308	Secondary # Zone 1 Alarm Restore Code	E1
309 - 310	Secondary # Zone 2 Alarm Restore Code	E2
311 - 312	Secondary # Zone 3 Alarm Restore Code	E3
313 - 314	Secondary # Zone 4 Alarm Restore Code	E4
315 - 316	Secondary # Zone 5 Alarm Restore Code	E5
317 - 318	Secondary # Zone 1 Disable Restore Code	E1
319 - 320	Secondary # Zone 2 Disable Restore Code	E2
321 - 322	Secondary # Zone 3 Disable Restore Code	E3
323 - 324	Secondary # Zone 4 Disable Restore Code	E4
325 - 326	Secondary # Zone 5 Disable Restore Code	E5
327 - 328	Secondary # Drill Restore Code	98
329 - 330	Secondary # AC Fault Restore Code	E6
331 - 332	Secondary # Zone 1 Fault Restore Code	E1
333 - 334	Secondary # Zone 2 Fault Restore Code	E2
335 - 336	Secondary # Zone 3 Fault Restore Code	E3
337 - 338	Secondary # Zone 4 Fault Restore Code	E4
339 - 340	Secondary # Zone 5 Fault Restore Code	E5
341 - 342	Secondary # Earth Fault Restore Code	E7
343 - 344	Secondary # Low Battery Fault Restore Code	E8
345 - 346	Secondary # No Battery Fault Restore Code	E9
347 - 348	Secondary # Telco Primary Line Fault Restore Code	EA
349 - 350	Secondary # Telco Secondary Line Fault Restore Code	EB
351 - 352	Secondary # NAC # 1 Fault Restore Code	EC
353 - 354	Secondary # NAC # 2 Fault Restore Code	EC
355 - 356	Secondary # Communication Trouble Primary # Restore Code	ED
357 - 358	Secondary # Communication Trouble Secondary # Restore Code	EE
359 - 360	Secondary # Annunciator Fault Restore Code	EC
361 - 362	Secondary # System Off Normal Restore Code	EF
363 - 364	Secondary # System Test Report	99
365 - 366	Secondary # System Abnormal Test Report	91
367 - 368	Secondary # Request for Upload/Download	71
369 - 370	Secondary # Successful Upload	72
371 - 372	Secondary # Successful Download	73
373 - 374	Secondary # Failed Upload/Download	74

Ademco Contact ID Format

If 'E' is entered for address 42 in Program Mode Level 1, the data shown in Table 3-6 is automatically programmed for the Secondary Central Station phone number event codes. Enter '000' for the setting to disable the report. The Setting entry is programmable, the Zone Number cannot be changed. Restoral code settings match the settings shown with the addition of an 'R' code transmitted. Refer to page 83 for additional information.

TABLE 3-6: Event Codes, Secondary Central Station Number

<u>Address</u>	<u>Description</u>	<u>Setting</u>	<u>Zone No.</u>
251-253	Secondary # Zone 1 Alarm Code	111	001
254-256	Secondary # Zone 2 Alarm Code	111	002
257-259	Secondary # Zone 3 Alarm Code	111	003
260-262	Secondary # Zone 4 Alarm Code	111	004
263-265	Secondary # Zone 5 Alarm Code	111	005
266-268	Secondary # Zone 1 Disabled Code	570	001
269-271	Secondary # Zone 2 Disabled Code	570	002
272-274	Secondary # Zone 3 Disabled Code	570	003
275-277	Secondary # Zone 4 Disabled Code	570	004
278-280	Secondary # Zone 5 Disabled Code	570	005
281-283	Secondary # Drill Code	604	000
284-286	Secondary # AC Fault Code	301	000
287-289	Secondary # Zone 1 Fault Code	380	001
290-292	Secondary # Zone 2 Fault Code	380	002
293-295	Secondary # Zone 3 Fault Code	380	003
296-298	Secondary # Zone 4 Fault Code	380	004
299-301	Secondary # Zone 5 Fault Code	380	005
302-304	Secondary # Earth Fault Code	310	000
305-307	Secondary # Low Battery Fault Code	302	000
308-310	Secondary # No Battery Fault Code	311	000
311-313	Secondary # Telco Primary Line Fault Code	351	000
314-316	Secondary # Telco Secondary Line Fault Code	352	000
317-319	Secondary # NAC #1 Fault Code	321	001
320-322	Secondary # NAC #2 Fault Code	322	002
323-325	Secondary # Comm Trouble Primary # Code	354	001
326-328	Secondary # Comm Trouble Secondary # Code	354	002
329-331	Secondary # Annunciator Fault Code	330	001
332-334	Secondary # System Off Normal Code	308	000
335-337	Secondary # System Test Message	602	000
338-340	Secondary # System Abnormal Test Message	608	000
341-343	Secondary # Upload/Download Request Code	411	000
344-346	Secondary # Upload Successful Code	416	000
347-349	Secondary # Download Successful Code	412	000
350-352	Secondary # Upload/Download Failed Code	413	000

Programming Options

Secondary Central Station Number Account Code (43-46)

A unique account code is provided by the Central Station. Four locations at addresses 43-46 (factory default settings of all '0s') are used to enter the account code. Valid entries are 0 to 9 and A to F. The number of digits entered must match the format selection. If programming '2, 3, 4 or 5' into address 42, enter the three digit account code supplied by the Central Station (location 46 is ignored). If programming '0, 1, 6, 7, 8, 9, A, B, C or D' into address 42, enter the four digit account code supplied by the Central Station.

Secondary Central Station Number 24 Hour Test Time (47-50)

Use military time when entering the 24 hour 'test' time. The 24 hour test report to phone number 2 takes up four locations, from addresses 47-50. The default is '0000' (12:00 midnight). The limits for each location are as follows:

47 - enter 0-2

48 - enter 0-9

49 - enter 0-5

50 - enter 0-9

Do not use 'A-F'

Secondary Central Station Number 24/12/8/6 Hour Test Time Interval (51)

The test report sent to the Secondary phone number may be sent every 6, 8, 12 or 24 hours. If the message is to be sent every 24 hours, leave the factory default entry of '0'. If other test report times are needed, enter '1' for 12 hours, '2' for 8 hours or '3' for 6 hours.

Alarm Verification (52)

Alarm verification works only on zones programmed as 2-wire smoke detector zones. After detecting an alarm, the panel removes power from all zones for six seconds, resetting all 2-wire smoke detectors. Power is reapplied and a 12 second retard period allows detectors to stabilize. During the retard/reset period of 18 seconds, subsequent alarms by the same initiating zone are ignored. An alarm detected on any other 2-wire detector zone during the retard period will cause immediate verified alarms. A subsequent alarm on the initiating zone occurring within the confirmation time will cause a verified alarm. *Note: Mixing devices on zones designated as 2-wire smoke zones is not recommended.*

During the alarm verification period, access to other modes of operation is prevented.

FIGURE 3-2: Verification Timing Diagram

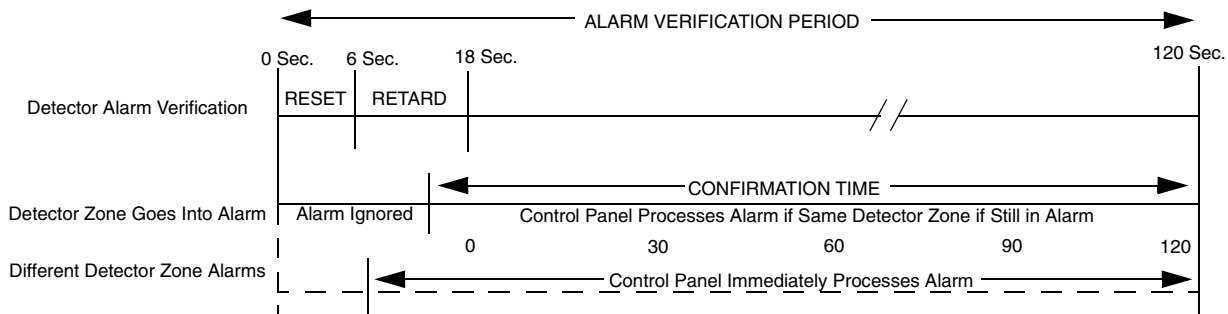

Factory default selection is no verification which is a '0' entry. Entering a '1' enables alarm verification. *Note: Consult local Authority Having Jurisdiction (AHJ) prior to altering this address.*

Future Use (53-55)

Slave Communicator/Fire Panel Selection (56)

Leaving address 56 at '0' causes the control panel to operate as a *fire panel only*. Selecting '1' will make it operate as a *slave communicator only*. Selecting '2' will make it operate as a *fire panel/communicator*.

Zones 1-5 Function Selection (57-61)

The five zones on the control panel may be programmed as shown below. Program entries alter zone function and transmittal priority.

When using Ademco Contact ID format, Zone Alarm and Zone Restoral event codes change automatically as shown in Table 3-7. Be certain to reprogram alarm event codes when selecting process monitoring functions. Zone fault and disable event codes may also be user reprogrammed (refer to “Ademco Contact ID Format Event Code Descriptions” on page 83).

TABLE 3-7: Zone Function Selection

<u>Program Entry</u>	<u>Function</u>	<u>Zone Alarm/Restoral¹ Event Code</u>
0	Operates 2-wire smoke detectors	111
1	Pull station	115
2	Normally open contact device	110
3	Supervisory	200
4	Supervisory autoresettable - self restore function, is not latched by the control panel	200
5	Waterflow silenceable - silencing of silenceable NACs allowed (affects zone 3 only)	113
6	Waterflow nonsilenceable - silencing of silenceable NACs is not allowed. Must clear waterflow alarm condition and press the reset key (affects zone 3 only)	113

1. Ademco Contact ID format selection causes Event Codes to automatically change to values shown in Table 3-7 .

Zone 1 Function Selection (57)

Factory default for zone 1 is '0' for 2-wire smoke detector. Enter '1' for pull station; '2' for normally open contact device; '3' for supervisory; '4' for supervisory autoresettable.

Zone 2 Function Selection (58)

Factory default for zone 2 is '0' for 2-wire smoke detector. Enter '1' for pull station; '2' for normally open contact device; '3' for supervisory; '4' for supervisory autoresettable.

Zone 3 Function Selection (59)

Factory default for zone 3 is '0' for 2-wire smoke detector. Enter '1' for pull station; '2' for normally open contact device; '3' for supervisory; '4' for supervisory autoresettable; '5' for waterflow silenceable; '6' for waterflow nonsilenceable.

Zone 4 Function Selection (60)

Factory default for zone 4 is '0' for 2-wire smoke detector. Enter '1' for pull station; '2' for normally open contact device; '3' for supervisory; '4' for supervisory autoresettable.

Zone 5 Function Selection (61)

Factory default for zone 5 is '0' for 2-wire smoke detector. Enter '1' for pull station; '2' for normally open contact device; '3' for supervisory; '4' for supervisory autoresettable.

Note: Programming any zone to function as supervisory or supervisory autoresettable will cause the defaulted event codes (see notes in Table 3-1 through Table 3-5) to be automatically changed. The defaulted code of '1' is changed to '8' for formats 3+1 and 4+1 Standard and Expanded, 4+2 Expanded and 4+1 Express. The defaulted codes of 11, 12, 13, 14 and 15 are changed to 81, 82, 83, 84 and 85 accordingly for formats 4+2 Standard and 4+2 Express.

Waterflow Retard Timer (62-63)

A delay may be added prior to declaring a waterflow type of alarm. Delays up to 89 seconds are allowed. The default for addresses 62 and 63 are '00' (no additional delay). Valid entries for address 62 are 0-8 and for address 63 are 0-9. Program entries into these addresses only if entering a '5' or '6' in address 59. *Be careful to include any built-in delays of the waterflow device.*

Programming Options

AC Loss Reporting Delay (64)

Enter a digit of '1'-F', corresponding to the number of hours to be delayed in reporting loss of AC power. The factory default setting is '0' for 6 hour delay. If 24 hour battery backup is being employed, select from choices '0' through '6'. If 60 hour backup is used, select from choices '7' through 'F'. Selections are: '0' for 6 hour delay; '1' for 7 hours; '2' for 8 hours; '3' for 9 hours; '4' for 10 hours; '5' for 11 hours; '6' for 12 hours; '7' for 15 hours; '8' for 16 hours; '9' for 17 hours; 'A' for 18 hours; 'B' for 19 hours; 'C' for 20 hours; 'D' for 21 hours; 'E' for 22 hours; 'F' for 23 hours.

Alarm Presignal (65)

Alarm Presignal is used to delay NAC (Notification Appliance Circuit) activation while allowing for visual verification by a person. Once a zone triggers an alarm, the main board piezo and the annunciator piezo sounders turn on steady, the display indicates the activated zone, the alarm LED blinks and the NACs are held off for 15 seconds. During this time, if the silence switch is pressed, the notification appliances may be held off for up to three minutes (see Presignal Delay Timer Address 66-68). After the programmed delay period, the notification appliances will activate. *Presignal does not function for zones defined as waterflow or supervisory.* Factory default is '0' for no alarm presignal. Enter '1' to select alarm presignal. During alarm presignal, access to other modes is prevented.

Alarm Presignal Delay Timer (66-68)

The alarm presignal delay timer is factory set to 120 seconds (2 minutes), address 66=1, 67=2 and 68=0. The timer may be programmed from 0 to 179 seconds. Location 65 must be set to '1' for the delay timer to operate.

Notification Appliance Circuit #1 Enable (69)

NAC #1 may be programmed as '0' for silenceable, '1' for nonsilenceable or '2' for disabled (disabling will cause the display to indicate 'bEL1', system trouble light to turn on and onboard piezo to sound). Factory default is '0' for silenceable. *Note: Consult the local Authority Having Jurisdiction (AHJ) prior to altering this address.*

Silence Inhibit Notification Appliance Circuit #1 (70)

Setting address 70 to '1' prohibits silencing of NAC #1 and the onboard piezo for one minute. Factory default is '0' for no silence inhibit of NAC #1.

Autosilence Notification Appliance Circuit #1 (71)

NAC #1 may be autosilenced after a programmed time interval between 5 and 30 minutes. Enter '1' for 5 minute autosilence, '2' for 10 minutes, '3' for 15 minutes, '4' for 20 minutes, '5' for 25 minutes or '6' for 30 minutes. The factory default is '0' for no autosilence.

Coding Notification Appliance Circuit #1 (72)

Coding of NAC #1 is programmable by selecting '1' for March Time (120 ppm), '2' for California (10 seconds On, 5 seconds Off) or '3' for Temporal (½ second On, ½ second Off, ½ second On, ½ second Off, ½ second On, 1½ seconds Off). Factory default is '0' for no coding (steady).

Notification Appliance Circuit #2 Enable (73)

NAC #2 may be programmed as '0' for silenceable, '1' for nonsilenceable or '2' for disabled (disabling will cause the display to indicate 'bEL2', system trouble light to turn on and onboard piezo to sound). Factory default is '0' for silenceable. *Note: Consult the local Authority Having Jurisdiction (AHJ) prior to altering this address.*

Silence Inhibit Notification Appliance Circuit #2 (74)

Setting address 74 to '1' prohibits silencing of NAC #2 and the onboard piezo for one minute. Factory default is '0' for no silence inhibit of NAC #2.

Autosilence Notification Appliance Circuit #2 (75)

NAC #2 may be autosilenced after a programmed time interval between 5 and 30 minutes. Enter '1' for 5 minute autosilence, '2' for 10 minutes, '3' for 15 minutes, '4' for 20 minutes, '5' for 25 minutes or '6' for 30 minutes. The factory default is '0' for no autosilence.

Programming Options

Coding Notification Appliance Circuit #2 (76)

Coding of NAC #2 is programmable by selecting '1' for March Time (120 ppm), '2' for California (10 seconds On, 5 seconds Off) or '3' for Temporal (½ second On, ½ second Off, ½ second On, ½ second Off, ½ second On, 1½ seconds Off). Factory default is '0' for no coding (steady).

Trouble Reminder (77)

Factory default is '0' which disables the trouble reminder feature. Selecting '1' will cause a reminding beep (after the silence switch is pressed), every 15 seconds during an alarm and every two minutes during a trouble condition. The beeps from the onboard piezo sounder will continue until the alarm or fault is cleared.

Annunciator/Printer Supervision (78)

Factory default is '0' for no annunciator or printer present. Set address 78 to '1' if an annunciator is present, set to '2' if a printer is present or set to '3' if both an annunciator and a printer are present.

Backup Reporting (79)

Leaving the default setting of '0' programs the control panel to transmit reports to the Secondary Central Station phone number only if attempts to communicate to the Primary Central Station phone number are unsuccessful. Programming a '1' causes all reports to be transmitted to the Secondary Central Station Phone number.

Touchtone/Rotary Select (80)

A '0' programmed in this address by the factory triggers Touchtone dialing over both phone lines. Select '1' for rotary dialing.

Make/Break Ratio (81)

Use this address only if '1' (rotary dialing) has been selected for address 80. The make/break ratio is factory set to '0' for 67/33 ratio, but may be changed to '1' for 62/38 ratio.

Address (82)

Leave default of '0'.

Address (83)

Leave default of '0'.

Panel Identification Number (84-87)

The Panel Identification Number is a 4-digit code (valid digits are 0-F) that is used to identify the installed panel. This code is separate from the 8-digit secret code loaded in by the Service Terminal. It is important to program this 4-digit code at the jobsite the first time that downloading is performed so that the called Service Terminal can identify the control panel.

Service Terminal Number 1 Phone Number (88-103)

Addresses 88 through 103 are reserved for the Service Terminal phone number 1. Factory default is all 'Fs'. Valid entries are 0-9 plus A, B, C, D and E, similar to the primary and secondary Central Station phone number entries programmed at addresses 00-15 and 26-41. Use 'F' to designate the end of the phone number.

Ring Count on Primary Phone Line (104-105)

Use this address to designate the number of rings allowed on the primary phone line prior to answering an incoming call from a Service Terminal. Factory default is '03' which means the panel will not answer an incoming call until 3 rings are detected. This entry may be programmed up to a maximum of 25 rings. A setting of '00' prevents the panel from answering incoming calls.

Programming Options

FAX/Answer Machine, Primary Phone Line (106)

This entry is used when the primary phone line is being shared with a FAX, answering machine or other device. Factory default is '0' for no sharing of the primary phone line. An entry of '1' indicates sharing and allows the panel to wait for three consecutive calls from the Service Terminal, spaced 30 seconds apart, before responding.

Service Terminal Number 2 Phone Number (107-122)

Addresses 107 through 122 are reserved for the Service Terminal phone number 2. Factory default is all 'Fs'. Valid entries are 0-9 plus A, B, C, D and E, similar to the primary and secondary Central Station phone number entries programmed at addresses 00-15 and 26-41. Use 'F' to designate the end of the phone number.

Ring Count on Secondary Phone Line (123-124)

Use this address to designate the number of rings allowed on the secondary phone line prior to answering an incoming call from a Service Terminal. Factory default is '03' which means the panel will not answer an incoming call until 3 rings are detected. This entry may be programmed up to a maximum of 25 rings. A setting of '00' prevents the panel from answering incoming calls.

FAX/Answer Machine, Secondary Phone Line (125)

This entry is used when the secondary phone line is being shared with a FAX, answering machine or other device. Factory default is '0' for no sharing of the secondary phone line. An entry of '1' indicates sharing and allows the panel to wait for three consecutive calls from the Service Terminal, spaced 30 seconds apart, before responding.

Upload/Download Reports Sent to Secondary Central Station Phone Number, Backup or Always (126)

Reports for request for 'upload/download', 'successful upload', 'successful download' and 'failed upload/download' are always sent to the primary Central Station phone number. This entry allows for the same reports to either always be sent to the secondary Central Station phone number or only if attempts to transmit to the primary Central Station phone number are unsuccessful. Factory default is '0' for backup only. Enter '1' for always.

Programming Event Codes (127-374)

The type of reports and event codes that are sent to the Central Station are in Table 3-1 through Table 3-5. The selections made for the Primary Central Station Number Communication Format (address 16) and the Secondary Central Station Number Communication Format (address 42) automatically program addresses 127-374 with factory default selections.

Any of the event codes may be changed. *Consult your Central Station prior to altering the event codes.* Entering an event code of '0' will cause the communicator to NOT transmit the report. For the 3+1, 4+1 and 4+1 Express formats or the 4+2 Expanded format, enter '0'. For the 4+2 Standard or 4+2 Express formats, enter '00'. Transmission of reports to *either or both* Central Station phone numbers may be disabled.

Note the special 'System Abnormal Test Report' event code. This report was added per new UL DACT requirements. This report is generated in place of the normal test report when an alarm and/or trouble condition exists at the time the test report is due to be sent.

Programming the Real-Time Clock and Calendar

Entering an address greater than 374 will cause a display of the current time. On initial power-up, the clock will start running from the factory setting of 00:01 (military time). The far left digit will be flashing, indicating that this is the first digit to be programmed. *It should be noted that setting the time and date may cause corruption of the History File. For this reason, it is important that the History File be cleared after the time and date has been set. Refer to "History Mode" on page 63.*

Hours/Minutes

Select a digit then press [ENTER/STORE]. The digit 2nd from the left will start flashing. Select a digit then press [ENTER/STORE]. Hours setting is complete. With the digit 2nd from the right flashing, select a digit then press [ENTER/STORE]. The digit on the far right will start flashing. Select a digit then press [ENTER/STORE]. Minutes setting is complete.

Default Programming

Year

After entering the last digit corresponding to minutes (far right digit), the display will read 1994 with the digit 9 (second from the right) flashing. Press [ENTER/STORE] if the 9 is acceptable. The digit farthest right will begin flashing. Enter the appropriate digit corresponding to the last digit of the current year and press the [ENTER/STORE] key to complete programming of the year.

Note that changing to the year 2000 can be accomplished by entering '0' while the second digit from the right is flashing, followed by the [ENTER/STORE] key. The two digits to the left will change to '20' and the digit farthest right will begin flashing. Enter the appropriate digit corresponding to the last digit of the year (i.e. '0' for the year 2000) and press the [ENTER/STORE] key to complete programming of the year.

Month/Day

After the year is entered, the display will show four digits representing the month and day of the software release date. The month is represented by the two digits on the left and the day by the two digits on the right. The digit on the far left will be flashing. The month and day are set the same way as the hours and minutes. Once the last digit corresponding to the day is entered, the display will show the contents of address '00'. The real-time clock/calendar keeps track of leap years automatically.

Note that the software for the MS-5024UD operates the internal clock based upon 60Hz. The software for the MS-5024UDE operates the internal clock based upon 50Hz.

End Programming

Exit Programming Mode by pressing **MODE**, followed by the 4-digit code corresponding to an alternate mode of operation, then press [ENTER/STORE].

During Program Mode, if no key is pressed within 10 minutes, the panel will return to Normal Mode.

3.4 Default Programming

To return all program entries to their factory original settings, perform the following steps only when the system is idle in Normal standby condition:

Press the **MODE** key followed by the four digit code **3337** and press the [ENTER/STORE] key.

☛ **3337** spells DEFP (**DE**fault **P**rogramming) on a Touch-Tone® phone

If an incorrect key is pressed, reenter the proper 4-digit code **before** pressing the [ENTER/STORE] key.

Within five seconds, repeat this entry by again pressing the **MODE** key followed by the 4-digit code **3337** and pressing the [ENTER/STORE] key. The display will read **3337** while the E² nonvolatile memory (storage area for all programming options) is being reprogrammed with the original default settings. When reprogramming is complete, the display will be blank.

CHAPTER 4 *Operating Instructions*



The MS-5024UD has six modes of operation:

- Normal Mode
- Program Mode
- Walktest Mode
- Troubleshoot Mode
- History Mode
- Print Mode

Upon initial power-up, the system will be in Normal Mode. This chapter discusses operation of the control panel in the Normal Mode.

4.1 Switches in Normal Mode

4.1.1 RESET

The Reset Switch resets the system and any smoke detectors. If the Reset Switch is pressed, the control panel will:

- ✓ Clear the display and status LEDs
- ✓ Turn off the Notification Appliance Circuits
- ✓ Reset all zones by temporarily removing power
- ✓ Silence the onboard piezo sounder
- ✓ Store 'reset' message in the History file
- ✓ Restore the alarm and trouble relays to normal
- ✓ Clear the supervisory and communication fail relay driver outputs
- ✓ Temporarily remove power from the resettable power output TB4 terminals 3 & 4
- ✓ Restore to normal the RM-5F zone relays
- ✓ Output 'reset' message to printer

Any alarm, supervisory or trouble condition that exists after a system reset, will resound the system, reactivating normal system activity. Upon release of the Reset Switch, the display will read **rES_** for six seconds.

Displays

SILENCE

If the Silence Switch is pressed:

- ✓ The silenceable NACs will be turned Off
- ✓ The silence LED will be turned Off
- ✓ The piezo sounder will be shut Off
- ✓ 'System Silenced' message will be stored in the History file
- ✓ 'System Silenced' message will be sent to the printer
- ✓ System Silence switch acts as acknowledge switch during alarm presignal

Upon the occurrence of a subsequent event (alarm or trouble), System Silence is overridden and the control panel will respond to the new event. *The System Silence switch will be ignored for silenceable waterflow type alarms.*

MODE

Pressing the **MODE** switch followed by a valid 4-digit numerical code and then the **[ENTER/STORE]** key selects one of the six modes of operation. To enter Normal Mode from any other mode, press **MODE**, then **6676** followed by the **[ENTER/STORE]** key.

☛ **6676** spells NORM on a Touchtone® phone.

1st EVENT

The 1st Event switch, along with the Up and Down arrow keys, is used to display any **currently** active alarm and/or fault conditions present in the system. Press the 1st Event switch at any time to display the first event (alarm and/or trouble) that occurred.

DOWN ARROW

The Down Arrow key is used to view other events (newer) that have occurred and are active (not yet cleared).

UP ARROW

The Up Arrow key is used to view other events (older) that have occurred and are active (not yet cleared).

[ENTER/STORE]

See individual mode descriptions in other sections of this manual.

4.2 Displays

Four 7-segment red LED characters provide visual annunciation of status, events and messages. A list of messages that may appear on the display in Normal Mode is shown below:

d_1	Zone 1 Disabled	F_1	Trouble Zone 1	SUP1	Supv. Alarm Zone 1
d_2	Zone 2 Disabled	F_2	Trouble Zone 2	SUP2	Supv. Alarm Zone 2
d_3	Zone 3 Disabled	F_3	Trouble Zone 3	SUP3	Supv. Alarm Zone 3
d_4	Zone 4 Disabled	F_4	Trouble Zone 4	SUP4	Supv. Alarm Zone 4
d_5	Zone 5 Disabled	F_5	Trouble Zone 5	SUP5	Supv. Alarm Zone 5
E_1	Zone 1 Enabled	F_A	Annunciator Fault	_AC_	AC Power Loss
E_2	Zone 2 Enabled	F_E	Earth Fault	rES_	System Reset
E_3	Zone 3 Enabled	Lo_b	Low Battery		
E_4	Zone 4 Enabled	no_b	No Battery		
E_5	Zone 5 Enabled	PH_1	Primary C.S.# Comm. Fault		
A_1	Alarm Zone 1	PH_2	Secondary C.S. # Comm. Fault		
A_2	Alarm Zone 2	bEL1	Bell 1 Fault or Disabled		
A_3	Alarm Zone 3	bEL2	Bell 2 Fault or Disabled		
A_4	Alarm Zone 4	no_1	Primary Phone Line Fault		
A_5	Alarm Zone 5	no_2	Secondary Phone Line Fault		

Displays

Individual LEDs are provided for:

System Alarm

A red LED that turns on steady when an alarm condition is detected and blinks during the alarm presignal period.

System Trouble

This yellow LED blinks to indicate that a fault or abnormal condition exists and that the fire alarm system may be inoperative. It turns on steady when the silence switch is pressed.

AC Power On

A green LED that remains on while the AC power supply is within correct limits. *If this indicator fails to light under normal conditions, service the system immediately.*

Supervisory

A yellow LED that blinks to indicate the need for action in connection with the supervision or maintenance of sprinklers, extinguishing systems or other protective systems.

System Silence

A yellow LED that turns on to indicate that an alarm or trouble condition exists in the system, but both NACs (if programmed as silenceable) and local piezo have been silenced.

Primary Line Active

A red LED on the main circuit board that indicates the primary phone line is active.

Secondary Line Active

A red LED on the main circuit board that indicates the secondary phone line is active.

Kissoff

A green LED on the main circuit board that blinks when a Central Station has acknowledged receipt of each transmitted message or when a portion of upload or download data has been accepted from a Service Terminal.

Modem

A green LED on the main circuit board that stays on steady during modem types of communications.

FIGURE 4-1: Phone Connectors and LEDs

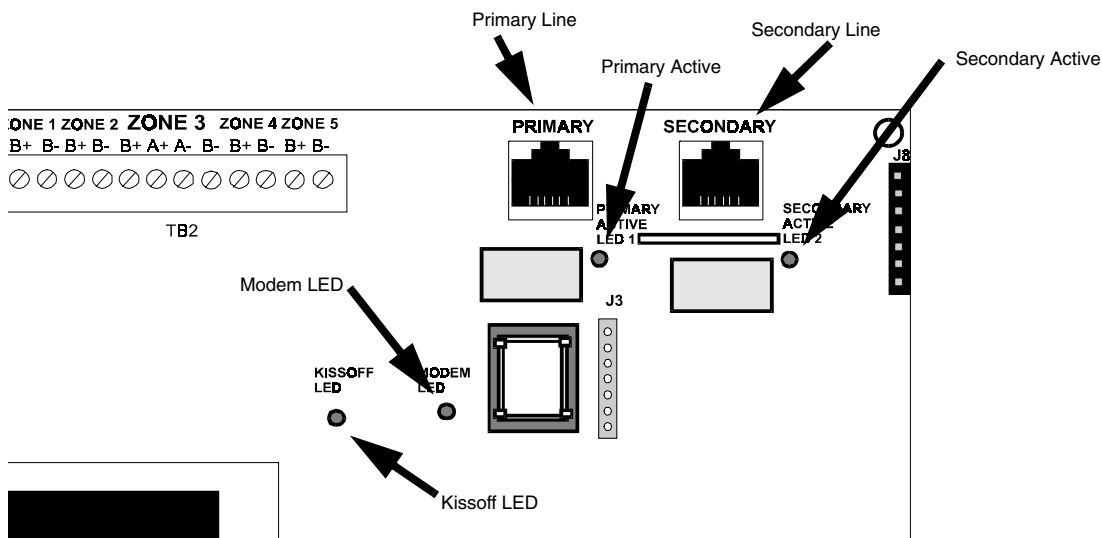

4.3 Operation

Normal Mode is the standard mode of operation. In this mode, the control panel continuously monitors system status. When no alarm or trouble conditions exist, the display will be blank and all LEDs will be off (except the AC Power LED). The Notifications Appliance Circuits will be off, all relays and relay drivers are normal and the onboard piezo sounder will be off. The communicator is not active, primary and secondary active LEDs are off.

All alarm and system trouble conditions are annunciated on the control panel's display. The control panel will maintain an 'active event list' which will consist of all alarms, supervisory alarms and system troubles currently active and not cleared, requiring immediate service. When the system is cleared and restored to normal, the display will be blank. All alarms and troubles are stored in a history file and may be recalled at any time.

Higher priority events take precedence over lower priority events. Display and reporting of system status is done on a priority basis. Priorities are, from highest to lowest:

1. Alarms
2. Supervisory Alarms
3. System Troubles

If the events to be displayed consist only of alarms and disabled zones (no troubles), the control panel will scroll them on the display. Pressing the 1st Event key will stop the scrolling and cause the display of the *first* alarm that occurred after the panel was last reset, cleared of all active events and placed into Normal Mode. Operation of the Up and Down arrow keys will display all remaining events in sequence.

If events to be displayed include system troubles, only one event is displayed at a time and there is no scrolling. The event displayed is the highest priority. Pressing the 1st Event key will cause the display of the first event that occurred after the panel was last reset, cleared of all active events and placed into Normal Mode. Operation of the Up and Down arrow keys will display all remaining events in order of their occurrences.

4.3.1 Alarm Response

Upon detection of an alarm condition, the control panel will:

- ✓ Turn the alarm LED on
- ✓ Activate the alarm relay
- ✓ Display the alarm message (i.e. **A__1** for alarm on zone 1)
- ✓ Communicate the alarm to the Central Station
- ✓ Store the alarm in the History file
- ✓ Turn the NACs on
- ✓ Turn the piezo sounder on
- ✓ Turn on appropriate zone relay output
- ✓ Output alarm message to printer
- ✓ Terminate upload or download communications

Note that when any zone is programmed as a supervisory zone, it will not be processed in the same manner as a conventional alarm zone. *See Supervisory Condition later in this section.*

Operation

4.3.2 Alarm Restoral

The control panel returns to normal only after all alarms have been cleared and the Reset switch has been pressed (pull stations reset, smoke detectors reset and no smoke is present, waterflow has stopped, etc.). Upon restoral of all active alarms, the control panel will perform the following:

- ✓ Turn off the alarm LED
- ✓ Deactivate the alarm relay
- ✓ Clear the 4-character display
- ✓ Send all 'zone restoral' messages to the Central Station
- ✓ Turn off the NACs
- ✓ Turn off the piezo sounder
- ✓ Turn off appropriate zone relay output
- ✓ Output 'zone restoral' message to printer
- ✓ Terminate upload or download communications

4.3.3 System Supervisory Condition Response

Program zones for supervisory in applications where a waterflow sensing device has been employed and the wiring to the waterflow valve and/or a tamper switch is to be monitored. If the tamper switch has been activated (normally open contacts close), a supervisory alarm condition will occur. When a supervisory condition occurs, the control panel will:

- ✓ Blink the supervisory LED (½ second On, ½ second Off)
- ✓ Activate the supervisory relay driver (TB4-5)
- ✓ Display the following message: **SUPX** where X = the zone number
- ✓ Communicate the supervisory condition to the Central Station
- ✓ Store the 'supervisory' message in the History file
- ✓ Pulse the piezo sounder at ½ second On and ½ second Off rate
- ✓ Turn on appropriate zone relay output
- ✓ Output system supervisory message to printer
- ✓ Terminate upload or download communications

4.3.4 System Supervisory Restoral Response

When the supervisory condition has been cleared (condition is restored and the reset switch has been pressed), the control panel will perform the following:

- ✓ Turn off the supervisory LED
- ✓ Deactivate the supervisory relay driver (TB4-5)
- ✓ Clear the display of the 'SUP' message
- ✓ Communicate a supervisory restoral message to the Central Station
- ✓ Shut off the piezo sounder
- ✓ Turn off appropriate zone relay output
- ✓ Output system supervisory restoral message to printer
- ✓ Terminate upload or download communications

Note: For any zone programmed for supervisory autoresettable, the Reset switch does not need to be pressed to clear the zone (supervisory condition).

4.3.5 Trouble Condition Response

Upon detection of one or more trouble conditions, the control panel will perform the following:

- ✓ Blink the trouble LED (1 second On and 1 second Off)
- ✓ Activate the trouble relay
- ✓ Display the appropriate trouble message(s) in priority fashion from the highest priority to the lowest.
Note that the Up Arrow, Down Arrow or 1st Event key must be pressed to view the messages
- ✓ Communicate the trouble conditions to the Central Station
- ✓ Store the trouble conditions in the History file
- ✓ Sound the piezo sounder 1 second On and 1 second Off
- ✓ Output the system trouble messages to the printer
- ✓ Terminate upload or download communications

Note: When AC brownout occurs, the AC LED is turned off and the trouble LED blinks. Should the brownout condition remain, it will be transmitted to the Central Station after a delay (see program address 64).

Possible trouble messages that may appear on the display are as follows:

d_1	Zone 1 Disabled	Lo_b	Low Battery
d_2	Zone 2 Disabled	no_b	No Battery
d_3	Zone 3 Disabled	PH_1	Primary C.S.# Comm. Fault
d_4	Zone 4 Disabled	PH_2	Secondary C.S. # Comm. Fault
d_5	Zone 5 Disabled	bEL1	Bell 1 Fault or Disabled
F_1	Trouble Zone 1	bEL2	Bell 2 Fault or Disabled
F_2	Trouble Zone 2	no_1	Primary Phone Line Fault
F_3	Trouble Zone 3	no_2	Secondary Phone Line Fault
F_4	Trouble Zone 4	_AC_	AC Power Loss (shown only when requested)
F_5	Trouble Zone 5		
F_A	Annunciator Fault		
F_E	Earth Fault		

4.3.6 Trouble Condition Restoral

Upon restoral of all trouble conditions, the control panel performs the following:

- ✓ Shut off the trouble LED
- ✓ Deactivates the trouble relay
- ✓ Turn off the AC Power LED if the trouble was loss of AC
- ✓ Clear the display of all trouble messages
- ✓ Communicate the restored trouble condition(s) to the Central Station
- ✓ Output the system trouble restoral message to the printer
- ✓ Terminate upload or download communications

4.3.7 Off Normal Reporting

Removing the control panel from Normal Mode and placing it into any other mode causes the transmission of an 'off normal' fault message to the Central Station. Returning the panel to Normal Mode causes the transmission of a 'return to normal' restoral message.

Operation

4.3.8 Zone Disable/Enable

The zone disable feature may be used to disable any zone in the system. Zones may be disabled if they are normal, in trouble or alarmed. *Zones may be disabled only during the Normal Mode of operation, when the fire protection is active. If the panel is in alarm, the silence switch must be pressed first, before the zone disable feature will function.*

To disable a zone, press the **MODE** key once (the display will go blank). You then have 10 seconds to start entering the code **3472**. Next press the **[ENTER/STORE]** key.

☛ **3472** spells DISA on a Touch-Tone® phone.

A flashing lower case **d** will appear on the far left of the display. Press the digit key corresponding to the zone number to be disabled. The number will appear on the far right of the display. Press **[ENTER/STORE]** to disable the zone. Note that the trouble relay is activated and the trouble LED blinks.

The zone disable message will remain on the display until the zone is reenabled. To reenable a zone, press the **MODE** key. The display will go blank. You then have 10 seconds to start entering the code **3622**. Next, press the **[ENTER/STORE]** key.

☛ **3622** spells ENAB on a Touch-Tone® phone.

A flashing upper case **E** will appear on the left of the display. Press the digit key corresponding to the zone number to be enabled. The number will appear on the far right of the display. Press the **[ENTER/STORE]** key to reenable the zone. Note that the trouble relay is restored to normal and the trouble LED turns off (if no other troubles are on the system).

4.3.9 Fire Drill

The Drill (manual evacuate) feature turns on both Notification Appliance Circuits (if programmed as enabled) and turns off the silence LED. To perform a fire drill, press the **MODE** key followed by the code **3745** then the **[ENTER/STORE]** key. The display will indicate **dril**. The alarm relay is not activated for a fire drill. There is an option to transmit the fire drill report code to the Central Station.

☛ **3745** spells DRIL on a Touch-Tone® phone.

During a fire drill, the Silence key will silence both NACs and the Reset key restores the control panel to normal. *All zones remain active during a fire drill.*

4.4 Central Station Communications

The control panel transmits zone and system status reports to Central Stations via the public switched telephone network. Two supervised telephone line connections are made to interface the control panel to the telephone lines. Two optional 7 foot telephone cords are available for this purpose and can be purchased separately.

The control panel supervised both telephone lines for proper voltage. A delay of two minutes will occur before a fault in either phone line connection is reported as a trouble. When a fault is detected, an audible trouble signal will sound, the yellow trouble LED will blink, the 4-character display will show either 'no 1' (primary line fault) or 'no 2' (secondary line fault) and the trouble condition will be reported to the Central Station over the remaining operational phone line.

The control panel comes with line seizure capability provided for both the primary and secondary telephone line interfaces. Any time that the control panel needs to make a call to a Central Station, line seizure will disconnect any local premises phones sharing the same telephone line.

All transmissions to the Central Stations will be sent over the primary phone line. In the event of noisy phone lines, transmissions will be sent over the backup secondary phone line.

Two phone numbers must be programmed, the primary Central Station phone number and the secondary Central Station phone number. All system reports will be transmitted to the primary Central Station phone number. Reports will automatically be sent to the secondary Central Station phone number if attempts to transmit to the primary Central Station phone number are unsuccessful. If 10 total attempts to communicate are unsuccessful, the Communicator Failure output will be turned on (TB4, Terminal 6). Note that as an option, *all* reports may also be sent to the secondary Central Station phone number.

The MS-5024UD meets NFPA 72 National Fire Code reporting requirements for: (a) the type of signal, (b) condition and (c) location of the reporting premises. The general priority reporting structure is:

1. Zone Alarms and Restores
2. Zone Troubles and Restores
3. System Troubles and Restores
4. 24-hour Test

Central Station Communications

The control panel is capable of reporting detailed messages depending upon the format in use. Table 4-1 shows the reporting structure for all formats.

TABLE 4-1: Format Selection Address (16 & 42)

	Format # 0, 2, 4, 6, 8	Format # 3, 5, 7, 9	Format # 1, A, C	Format B, D
Report	3+1/4+1/Standard 4+1 Express	3+1/4+1/Expanded	4+2/Standard 4+2 Express	4+2/Expanded
Alarm	SSS(S) A	SSS(S) A AAA(A) Z	SSSS AA2	SSSS AZ
Alarm Restore	SSS(S) RA	SSS(S) RA RARARA(RA) Z	SSSS RARA2	SSSS RAZ
Zone Trouble (Zone Open)	SSS(S) TZ	SSS(S) TZ TZTZTZ(TZ) Z	SSSS TZTZ2	SSSS TZZ
Zone Trouble Restore	SSS(S) RTZ	SSS(S) RTZ RTZRTZRTZ(RTZ) Z	SSSS RTZRTZ2	SSSS RTZZ
System Trouble	SSS(S) TS	SSS(S) TS TSTSTS(TS) Y	SSSS TSTS2	SSSS TSY
System Trouble Restore	SSS(S) RTS	SSS(S) RTS RTSRTSRTS(RTS) Y	SSSS RTSRTS2	SSSS RTSY
Zone Disable	SSS(S) DZ	SSS(S) DZ DZDZDZ(DZ) Z	SSSS DZDZ2	SSSS DZZ
Zone Disable Restore	SSS(S) RDZ	SSS(S) RDZ RDZRDZRDZ(RDZ) Z	SSSS RDZRDZ2	SSSS RDZZ
Low Battery	SSS(S) L	SSS(S) L	SSSS LL2	SSSS LL2
Low Battery Restore	SSS(S) RL	SSS(S) RL	SSSS RLRL2	SSSS RLRL2
AC Loss	SSS(S) P	SSS(S) P	SSSS PP2	SSSS PP2
AC Loss Restore	SSS(S) RP	SSS(S) RP	SSSS RPRP2	SSSS RPRP2
Fire Drill	SSS(S) Fd	SSS(S) Fd	SSSS FdFd2	SSSS FdFd2
Fire Drill Restore	SSS(S) RFd	SSS(S) RFd	SSSS RFdRFd2	SSSS RFdRFd2
Supervisory Condition	SSS(S) V	SSS(S) V VVV(V) Z	SSSS VV2	SSSS VZ
Supervisory Condition Restore	SSS(S) RV	SSS(S) RV RVRVRV(RV) Z	SSSS RVRV2	SSSS RVZ
Test Report	SSS(S) X	SSS(S) X	SSSS XX2	SSSS XX2
Upload or Download	SSS(S) UD	SSS(S) UD	SSS UDUD2	SSS UDUD2

Refer to Table 4-2 for an explanation of each letter code in Table 4-1. Refer to Table 4-3 for a list of compatible receivers.

TABLE 4-2: Format Selection Address Explanation

Where

SSS or SSSS	=	Subscriber ID
A	=	Alarm (1st digit)
A2	=	Alarm (2nd digit)
Z	=	Zone Number
RA	=	Alarm Restore (1st digit)
RA2	=	Alarm Restore (2nd digit)
TZ	=	Zone Trouble (1st digit)
TZ2	=	Zone Trouble (2nd digit)
RTZ	=	Zone Trouble Restore (1st digit)
RTZ2	=	Zone Trouble Restore (2nd digit)
TS	=	System Trouble (1st digit)
TS2	=	System Trouble (2nd digit)
RTS	=	System Trouble Restore (1st digit)
RTS2	=	System Trouble Restore (2nd digit)
DZ	=	Zone Disable (1st digit)
DZ2	=	Zone Disable (2nd digit)
RDZ	=	Zone Disable Restore (1st digit)
RDZ2	=	Zone Disable Restore (2nd digit)
L	=	Low Battery (1st digit)
L2	=	Low Battery (2nd digit)
RL	=	Low Battery Restore (1st digit)
RL2	=	Low Battery Restore (2nd digit)
P	=	AC Loss (1st digit)
P2	=	AC Loss (2nd digit)
RP	=	AC Loss Restore (1st digit)
RP2	=	AC Loss Restore (2nd digit)
FD	=	Fire Drill (1st digit)
FD2	=	Fire Drill (2nd digit)
RFD	=	Fire Drill Restore (1st digit)
RFD2	=	Fire Drill Restore (2nd digit)
V	=	Supervisory Condition (1st digit)
V2	=	Supervisory Condition (2nd digit)
RV	=	Supervisory Condition Restore (1st digit)
RV2	=	Supervisory Condition Restore (2nd digit)
X	=	Test Report (1st digit)
X2	=	Test Report (2nd digit)
Y	=	A trouble corresponding to the following:
	7 =	Ground Fault
	8 =	Low Battery
	9 =	No Battery
	A =	Telco Primary Line Fault
	B =	Telco Secondary Line Fault
	C =	Main Bell Fault, Annunciator Bell
	D =	Communication Fault to Primary Number
	E =	Communication Fault to Secondary Number
	F =	System Off Normal Fault/System Fault (Slave Operation, see Chapter 6)
UD	=	Upload/download (1st digit)
UD2	=	Upload/download (2nd digit)

Note: For Expanded Reporting, the control panel automatically adds the digit corresponding to the zone number and the second digit corresponding to any system trouble condition. Only the first digit is programmable.

4.4.1 Transmittal Priorities

The integral communicator transmits highest priority events first. Events, in terms of priority, are listed below in descending order:

1. Alarms (highest priority level)
 - ✓ Pull stations
 - ✓ Waterflow
 - ✓ Smoke detector
 - ✓ Other alarm types
2. Supervisory Zone
3. System Troubles
 - ✓ Zone disabled
 - ✓ Fire drill
 - ✓ AC fail (after delay)
 - ✓ Zonal faults
 - ✓ Earth fault
 - ✓ Low battery/no battery
 - ✓ Telephone line fault
 - ✓ Notification Appliance Circuits fault
 - ✓ Communication trouble
 - ✓ Annunciator trouble
 - ✓ System off normal
4. Restoral Reports
 - ✓ Zone alarm
 - ✓ Supervisory
 - ✓ Zone(s) enabled
 - ✓ Fire drill
 - ✓ AC
 - ✓ Zone fault
 - ✓ Earth
 - ✓ Battery
 - ✓ Telephone line
 - ✓ Notification Appliance Circuits
 - ✓ Communication
 - ✓ Annunciator trouble
 - ✓ System off normal
5. 24 Hour Test (lowest priority)

Red LEDs are provided on the control panel circuit board to identify which telephone line is activated. Also, a green LED labeled 'kissoff' will turn on whenever the control panel has successfully transmitted reports to the Central Station. The 'kissoff' LED may turn on several times during communications with a Central Station.

Central Station Communications

The table below shows UL listed receivers which are compatible with the MS-5024UD.

TABLE 4-3: Compatible UL Listed Receivers

	Format # (Addresses 16 & 42)	Ademco 685 (1)	Silent Knight 9000 (2)	ITI CS-4000 (3)	FBI CP220FB	Osborne Hoffman Models 1 & 2	Radionics 6000 (6)	Radionics 6500 (5)	Sescoa 3000R (7)	Surguard MLR-2 (9)
0	4+1 Ademco Express	✓			✓					✓
1	4+2 Ademco Express	✓			✓	✓ (8)				✓
2	3+1/Standard/1800/2300	✓	✓	✓	✓ (4)	✓	✓	✓	✓	✓
3	3+1/Expanded/1800/2300	✓	✓	✓	✓ (4)	✓			✓	✓
4	3+1/Standard/1900/1400	✓	✓		✓ (4)	✓			✓	✓
5	3+1/Expanded/1900/1400	✓	✓		✓ (4)	✓			✓	✓
6	4+1/Standard/1800/2300	✓	✓	✓	✓ (4)	✓		✓	✓	✓
7	4+1/Expanded/1800/2300	✓	✓		✓ (4)	✓			✓	✓
8	4+1/Standard/1900/1400	✓	✓		✓ (4)	✓			✓	✓
9	4+1/Expanded/1900/1400	✓	✓		✓ (4)	✓			✓	✓
A	4+2/Standard/1800/2300	✓	✓	✓	✓ (4)	✓		✓	✓	✓
B	4+2/Expanded/1800/2300	✓	✓		✓ (4)	✓			✓	✓
C	4+2/Standard/1900/1400	✓	✓		✓ (4)	✓			✓	✓
D	4+2/Expanded/1900/1400	✓	✓		✓ (4)	✓			✓	✓
E	Ademco Contact ID	✓			✓	✓				✓
F	Not Used									

1. With 685-8 Line Card with Rev. 4.4d software
2. With 9002 Line Card Rev. 9035 software or 9032 Line Card with 9326A software
3. Rev. 4.0 software
4. FBI CP220FB Rec-11 Line Card with Rev. 2.6 software and a memory card with Rev. 3.8 software
5. Model 6500 with Rev. 600 software
6. Mode 6000 with Rev. 204 software
7. With Rev. B control card at Rev. 1.4 software and Rev. C line card at Rev. 1.5 software
8. Model 2 only
9. Version 1.62 software

CHAPTER 5 *Servicing*

5.1 Walktest Mode

The MS-5024UD provides the capability to perform a one-man walktest of the system without triggering the communicator, the zone relays or the alarm output relay. Walktest allows for testing of the five zones (Initiating Device Circuits). The first initiating device activated on a zone will cause the Notification Appliance Circuits to turn on for four seconds. Subsequent device activations on the same zone will cause the NACs to turn on for one second. Any smoke detectors that are activated will be reset. Zonal faults (open circuits) will cause the NAC to remain on steady. Prior to entering Walktest Mode, check to be certain that all system faults have been cleared. *Note that the trouble relay will be activated while the control panel is in Walktest Mode. Placing the control panel into this mode will only be possible if the system has no active alarms.*

Pressing the **MODE** key followed by the 4-digit code **9255** and then the **[ENTER/STORE]** key will place the control panel into Walktest Mode.

☛ **9255** spells WALK on a Touch-Tone® phone.

Once in Walktest Mode, the control panel will immediately:

- ✓ Blink the trouble LED
- ✓ Activate the trouble relay
- ✓ Turn on the NACs for four seconds for the first alarm on a zone. Subsequent alarms on the same zone will sound for one second. Troubles cause the NACs to remain on
- ✓ Disable the alarm relay
- ✓ Display all alarm conditions as they occur
- ✓ Display all zone troubles as they occur
- ✓ Display ground faults as they occur
- ✓ Transmit 'off normal' message to Central Station(s)
- ✓ Continue to communicate any events not acknowledged at a Central Station prior to entering Walktest Mode

During Walktest Mode, zonal activity is displayed in real-time as it occurs. At the end of walktesting the system, the display will show the last event that occurred. To view all events stored during Walktest, use the Up arrow, Down arrow and 1st Event keys. The Down arrow key moves the Walktest list to show older (previous) events. The Up arrow key moves the Walktest list to show newer (more recent) events. Pressing the 1st Event key at any time will cause the display of the first event stored upon initial entry into Walktest Mode. While in Walktest Mode, the control panel will store up to 128 events in the Walktest File for later recall and display. A printer may be connected to the panel during Walktest. All Walktest events are printed in real-time as they occur.

To return the control panel to Normal Mode, press the **MODE** key followed by the code **6676** and then the **[ENTER/STORE]** key. Any delay between key presses greater than 10 seconds causes the control panel to remain in Walktest Mode.

The control panel will automatically return to Normal Mode if no system activity has occurred for 60 minutes. This includes pressing any keys or activity on any zone. Exiting Walktest Mode leaves the Walktest file in memory such that it may be printed in Print Mode. Subsequent entries into Walktest Mode will delete the Walktest file. *Note that remote site upload or download is not possible while in Walktest Mode.*

5.2 History Mode

All Normal Mode events are stored in a History File list for future recall. Recall is possible via the 4-character display or via an optional printer. The History File list is a first-in, first-out (FIFO) file. In this manner, only the most recent events may be called up from memory. Older events will be overwritten, that is, pushed out of the FIFO file. The number of stored events is 32 maximum. The History File is kept in E² memory. Complete power loss will not erase the list.

Pressing the **MODE** key followed by the code **4478** and then the **[ENTER/STORE]** key places the control panel into History Mode. This will not occur if there are any active alarm conditions present. The event displayed, is the most recent event.

☛ **4478** spells HIST on a Touch-Tone® phone.

Once in History Mode, the control panel will:

- ✓ Blink the trouble LED
- ✓ Activate the trouble relay
- ✓ Disable the Notification Appliance Circuit(s)
- ✓ Disable the alarm relay
- ✓ Display all events as they occurred since the last time the History File list was cleared. The most recent event will be displayed first
- ✓ Ignore all other keys other than those mentioned in this section
- ✓ Transmit the 'off normal' message to the Central Station(s)
- ✓ Continue to communicate any events not previously acknowledged at the Central Station prior to entering History Mode

The Down Arrow key moves the History File to show older (previous) events. The Up Arrow key moves the History file to show newer (more recent) events. Following is a list of messages as they will appear on the display:

d__1	Zone 1 Disabled	F__1	Trouble Zone 1	SUP1	Supv. Alarm Zone 1
d__2	Zone 2 Disabled	F__2	Trouble Zone 2	SUP2	Supv. Alarm Zone 2
d__3	Zone 3 Disabled	F__3	Trouble Zone 3	SUP3	Supv. Alarm Zone 3
d__4	Zone 4 Disabled	F__4	Trouble Zone 4	SUP4	Supv. Alarm Zone 4
d__5	Zone 5 Disabled	F__5	Trouble Zone 5	SUP5	Supv. Alarm Zone 5
E__1	Zone 1 Enabled	F__A	Annunciator Fault	_AC_	AC Power Loss
E__2	Zone 2 Enabled	F__E	Earth Fault	SILE	Silence Switch Pressed
E__3	Zone 3 Enabled	Lo_b	Low Battery	rES_	Reset Switch Pressed
E__4	Zone 4 Enabled	no_b	No Battery		
E__5	Zone 5 Enabled	PH_1	Primary C.S.# Comm. Fault		
A__1	Alarm Zone 1	PH_2	Secondary C.S. # Comm. Fault		
A__2	Alarm Zone 2	bEL1	Bell 1 Fault or Disabled		
A__3	Alarm Zone 3	bEL2	Bell 2 Fault or Disabled		
A__4	Alarm Zone 4	no_1	Primary Phone Line Fault		
A__5	Alarm Zone 5	no_2	Secondary Phone Line Fault		

It should be noted that setting the time and date may cause corruption of the History File contents. The History File should therefore be cleared after the time and date are set. To clear the list from E² memory, press the **SILENCE** key twice before exiting the History Mode.

A lack of keyboard activity for a period of 10 minutes will cause the control panel to return to Normal Mode. If a printer is connected to the control panel, the History File will be printed upon successful entry into History Mode and a list of the most recent 32 events, time and date stamped, will print out. *Note that remote site upload or download is not possible while the panel is in History Mode.*

5.3 Troubleshoot Mode

In Troubleshoot Mode, system voltages may be displayed on the 4-character display. An internal voltmeter measures the voltage present at:

- Zone inputs
- AC power input
- Battery terminal leads
- NAC #1
- NAC #2
- Resettable 24 volt power output

To enter Troubleshoot Mode, press the **MODE** key followed by the code **8768** and then the **[ENTER/STORE]** key. A lack of keyboard activity for a period of 20 minutes will cause the control panel to return to Normal Mode.

☎ **8768** spells TROU on a Touch-Tone® phone.

Once in Troubleshoot Mode, the control panel will:

- ✓ Blink the trouble LED
- ✓ Activate the trouble relay
- ✓ Disable the NACs
- ✓ Disable the alarm relay
- ✓ Transmit the 'off normal' message to the Central Station(s)
- ✓ Continue to communicate any events not yet acknowledged at the Central Station prior to entering Troubleshoot Mode

Voltages can be viewed by performing the following steps:

- AC input voltage - press **A** and then the **[ENTER/STORE]** key
- Battery voltage - press **B** and then the **[ENTER/STORE]** key
- Zone 1 voltage - press **1** and then the **[ENTER/STORE]** key
- Zone 2 voltage - press **2** and then the **[ENTER/STORE]** key
- Zone 3 voltage - press **3** and then the **[ENTER/STORE]** key
- Zone 4 voltage - press **4** and then the **[ENTER/STORE]** key
- Zone 5 voltage - press **5** and then the **[ENTER/STORE]** key
- NAC #1 voltage - press **b** then **1** and then the **[ENTER/STORE]** key
- NAC #2 voltage - press **b** then **2** and then the **[ENTER/STORE]** key
- Resettable 24 volt power - press the **RESET** key and then the **[ENTER/STORE]** key

5.3.1 Zone Voltages

The nominal threshold voltages for each zone are listed below. Actual readings will vary depending upon system load and AC line voltage.

TABLE 5-1: Nominal Zone Voltages

<u>Zone #</u>	<u>Normal w/E.O.L.</u>	<u>Shorted</u>	<u>Open Circuit</u>
1	23.5V	0.00V	25.4V
2	23.5V	0.00V	25.4V
3	23.5V	0.00V	25.4V
4	23.5V	0.00V	25.4V
5	23.5V	0.00V	25.4V

5.3.2 AC Line Voltage

The following table lists the AC line voltage range. The AC On indicator will turn off when the AC line voltage drops below the Low Line threshold and the trouble LED will turn on.

TABLE 5-2: AC Line Voltage Range

<u>AC Line Voltage</u>	<u>Low Line</u>	<u>Normal</u>	<u>High Line</u>
MS-5024UD	102 VAC	115 VAC	132 VAC
MS-5024UDE	204 VAC	220 VAC	264 VAC

5.3.3 Battery Voltage

The following table lists the critical battery threshold conditions. *Note that battery measurements should be made after allowing 48 hours to charge depleted batteries. If batteries do not show normal readings, replace them.*

IMPORTANT: The battery charger will turn off when the battery voltage drops to 17.4 VDC or less (No Battery condition). A battery with a higher voltage must be installed to turn the charger back on.

TABLE 5-3: Battery Voltage

	<u>Normal</u>	<u>Low Battery</u>	<u>No Battery</u>
Battery Voltage:	27.6V	20.4V	<17.4V

5.3.4 Telephone Lines

Pressing **C** for touchtone dialing or **D** for rotary dialing, followed by **[ENTER/STORE]** causes seizure of the primary phone line which in turn lights the red LED signifying primary phone line active. After a delay of three seconds, the control panel goes off-hook to acquire a dial tone.

The control panel keypad may be used as a telephone touchpad for number dialing. Once the first digit is pressed, the display will move the **C** or **D** character one position to the left, while placing the digit to be dialed on the farthest right display position. Continue to press the phone numbers to be dialed. Successive depressions of the **[ENTER/STORE]** key hangs up and picks up the phone (places the phone on or off the hook).

The secondary phone line may be tested by pressing the **E** key for touchtone dialing or the **F** key for rotary dialing and then following the same procedure used for the primary phone line.

A handset may be temporarily connected across transformer T1 as indicated in Figure 5-1. The handset, when connected across T1, may be used only as an amplifier/speaker and telephone with the control panel used for number dialing.

FIGURE 5-1: Phone Connectors and LEDs

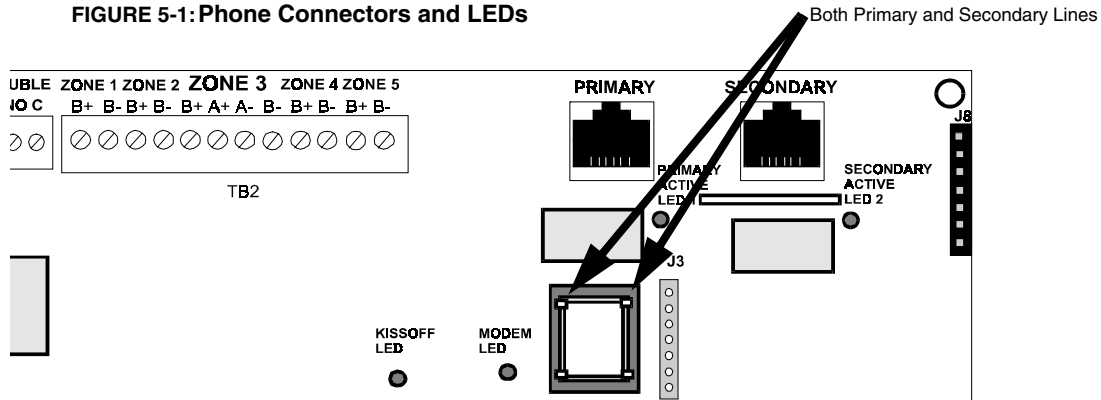

Lamp Test

5.3.5 NAC 1 & 2

NAC voltage readings are nominally -2.32 volts when an EOL resistor of correct value is in place. A reading of 0.00 volts appears for shorts, -4.50 volts for opens. Intermediate readings are also available.

Note that remote site upload or download is not possible while the panel is in Troubleshoot or Lamp Test Mode.

5.3.6 Resettable Power

Resettable 24 volt power output must read 24 volts, + or - 10%.

5.4 Lamp Test

To perform a Lamp Test, press **MODE** then the code **5267** followed by the **[ENTER/STORE]** key. This will test all system LEDs. The LEDs will remain on for five seconds and then the control panel will return to Normal Mode.

☛ **5267** spells LAMP on a Touch-Tone® phone.

5.5 Print Mode

A printer may be temporarily or permanently connected to the control panel. Refer to Figure 2-15 on page 30, for proper PRT-24 Printer Interface module connection to the main circuit board before proceeding.

Programmable option address 78 must be programmed to a '2' if only a printer is connected to the control panel or '3' if both a printer and annunciator are connected to the control panel, to enable printer supervision. Once enabled, normal system status as well as panel operations will be printed. If the printer connection is removed, the trouble LED will blink, the piezo sounder will pulse and the 4-character LED display will be blank.

Select Printer Mode by pressing the **MODE** key followed by the code **7746** and then the **[ENTER/STORE]** key. The display will read **Prn** and the following will be printed:

1. Entire program entries
2. History file
3. Walktest file
4. Troubleshoot Mode voltages
5. Current system status

(Note that all activity is time and date stamped)

Upon entering the Print Mode, the control panel will transmit the 'system off normal' message to the Central Station. The panel will return to Normal Mode automatically after printing is completed. This will typically take three minutes.

Note that remote site upload or download is not possible while the panel is in Print Mode.

CHAPTER 6 *Slave Communicator Configuration*

The MS-5024UD may be used as a slave communicator to a host or master FACP (fire alarm control panel). All wiring between the master and the slave communicator is supervised. 4.7K ohm End-of-Line resistors should be connected.

In slave configuration, the five zones become five channels that may be triggered by the relay outputs of any host FACP. The five channels function as follows:

- Zone/Channel 1 - general alarm
- Zone/Channel 2 - general trouble
- Zone/Channel 3 - may be programmed to match the FACP relay function
- Zone/Channel 4 - supervisory
- Zone/Channel 5 - may be programmed to match the FACP relay function

The factory settings for Zone/Channel 2 alarm and restoral are altered as follows:

- If 0, 2, 3, 4, 5, 6, 7, 8, 9, B or D is entered for address 16 or 42, the report code for Zone 2 Alarm Code (address 128 & 252) is 'F' and the Zone 2 Restoral Code (address 156 & 280) is 'E'.
- If I, A or C is entered for addresses 16 or 42, the report code for Zone 2 Alarm Code (addresses 129-130 & 253-254) is 'FF' and the Zone 2 Restoral Code (addresses 185-186 & 309-310) is 'EF'.
- If E is entered for addresses 16 or 42, the report code for Zone 2 Alarm Code and Restoral Code (addresses 130-132 & 254-256) is '300.'

The factory settings for Zone/Channel 4 alarm and restoral are altered as follows:

- If 0, 2, 3, 4, 5, 6, 7, 8, 9, B or D is entered for address 16 or 42, the report code for Zone 4 Alarm Code (address 130 & 254) is '8' and the Zone 4 Restoral Code (address 158 & 282) is 'E'.
- If I, A or C is entered for addresses 16 or 42, the report code for Zone 4 Alarm Code (addresses 133-134 & 257-258) is '84' and the Zone 4 Restoral Code (addresses 189-190 & 313-314) is 'E4'.
- If E is entered for addresses 16 or 42, the report code for Zone 4 Alarm Code and Restoral Code (addresses 136-138 & 260-262) is '200.'

Location 56 must be programmed to a '1' to enable the control panel as a slave communicator.

Note that remote site upload or download is permitted in the Slave Communicator configuration, however, alarm presignal and verification do not function in Slave mode.

Be certain to connect the slave communicator's primary AC power to the same branch circuit as the host FACP.

FIGURE 6-1: Slave Communicator Connections

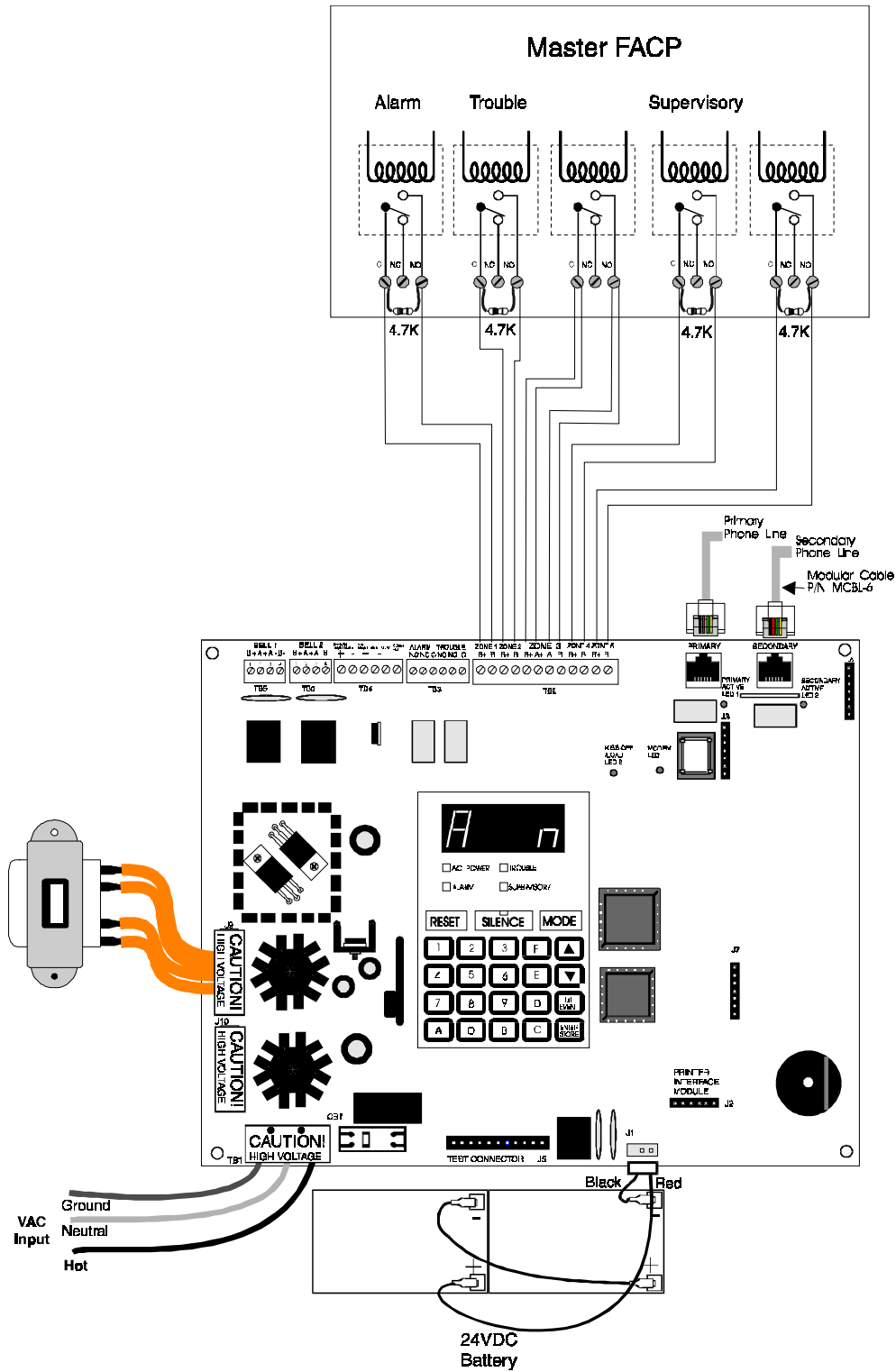

Relays in the master FACP activate various input circuits on the slave communicator. Messages (event codes) programmed for a particular input circuit (channel) will be transmitted to the Central Station upon relay activation.

CHAPTER 7 *Remote Site Upload/Download*

The control panel may be programmed or interrogated off-site via the public switched telephone network. Any personal computer with DOS™ 4.01 or greater plus Windows™ 3.1 or greater, with a 1200 baud Hayes™ compatible modem and Fire•Lite Upload/Download software P/N PK-5024UD, may serve as a Service Terminal. This allows download of the entire program or upload of the entire program, history file, walktest data, current status, system voltages, time and date.

CAUTION: After successfully downloading a program, make certain to perform the following steps:

1. Print out all programmed data via Print Mode or manually view programmed entries and compare to intended program data
2. Test all affected panel operations
3. Immediately correct any problems found

7.1 Downloading Program

The first time that the control panel is downloaded (whether initiated at the jobsite or remotely), a secret code is loaded in by a Service Terminal. Future upload or download requests cause verification of the secret code by the control panel before processing of data is allowed. If the secret code is not verified, the control panel will terminate the request.

While the control panel is communicating with the Service Terminal, the panel's green Modem LED and one of the red Line Seize LEDs will remain on steady. At the conclusion of a successful download, the green Kissoff LED will turn on steady for five seconds, the green Modem LED will turn off and the red Line Seize LED will turn off.

In order to download the panel (whether initiated at the jobsite or remotely), the following must be true:

- ✓ The control panel must be in the Normal Mode of operation. Downloading is not possible if the panel is in any other mode
- ✓ There cannot be any active communications ongoing with a Central Station receiver
- ✓ All active events must be successfully 'kissed-off' by the Central Station(s). The communicator must be in a standby state with no new information waiting to be transmitted to a Central Station

With program address location 56 set to '1' or '2', anytime a download is initiated, the control panel will first contact the primary Central Station or both the primary and secondary Central Stations to report a 'request for upload/download' message. Once the request is 'kissed-off' by the Central Station(s), the control panel will then call the appropriate Service Terminal and begin the downloading process.

To prevent the 'request for upload/download' message(s) from being reported to the Central Station(s), make certain to leave address 56 set to '0' or disable all upload/download reports back to both Central Stations.

During the downloading process, the fire protection remains active. Should a system trouble or alarm condition occur, the control panel immediately terminates downloading and processes the trouble or alarm locally and transmits the information to the Central Station(s).

7.1.1 Security Features

Remote site upload and download with the control panel has been carefully designed to include key security features to ensure proper functionality. The key features are listed and explained below.

Secret Code Verification

A secret code is stored in the control panel by a Service Terminal to prevent unauthorized access. The secret code is created at the Service Terminal by the master user and cannot be viewed or changed by anyone other than a master user. Viewing of the secret code is prohibited at the control panel. Prior to allowing an upload or download of data, the control panel will verify the secret code transmitted by the Service Terminal.

Time-out at Control Panel

Upon answering an incoming call on either the primary or secondary Central Station phone line, the control panel will listen for a modem connection signal. If this signal is not received within 30 seconds, the control panel will disconnect the call.

Callback to Service Terminal

Any time the control panel is requested to allow an upload or download, it will confirm the source of the incoming call, hang-up and call back the calling party (Service Terminal phone number).

Panel Identification Number

The panel identification number is typically used to identify the panel to the Service Terminal when the control panel calls the Service Terminal. If more than one call comes into the Service Terminal, the control panel ID number is used to sort out the calling parties.

Another use of this code allows for identical secret codes to be placed into multiple control panels at one jobsite, using the panel ID number to distinguish between the individual panels.

Error Checking

As each block of data is received by the control panel, it is checked for accuracy. If an error is detected, the block is retransmitted until correct, up to a maximum of four times. If the Secret Code is not verified and four errors occur, the call is disconnected and the report that the upload/download was not successful is called to the Central Station(s).

Central Station Acknowledge

There is an option, referred to as the 'callback' option, whereby the control panel will report to one or both Central Stations that a request for uploading or downloading has been received prior to processing the call. If the Central Station(s) does not acknowledge receipt of this request, uploading or downloading is prohibited. If acknowledged by the Central Station(s), another message is transmitted, informing the Central Station(s) that:

- Downloading was successful
- Uploading was successful
- Uploading/downloading was not successful

Central Station Data Protection

Addresses '00' through '51' are assigned to the primary and secondary Central Station phone number, communication format, account code and test time. Addresses '127' through '374' are reserved for the programmable event codes. This block of addresses holds the entire vital Central Station information. These blocks are protected from partial programming due to faulty phone connections, line noise and other errors. This prevents the panel from being confused due to a wrong phone number, account code, test time and most critical formatting errors.

7.2 Downloading Initiated at Control Panel

Before initiating the download procedure, make certain that the control panel is:

- ✓ *In Normal Mode*
- ✓ *Central Station communications are off or location 56 is set to '0'*
- ✓ *The communicator is in the standby state (red Line Seize LEDs are off, green Modem and Kissoff LEDs are off)*

Place the control panel into Program Mode and program one or both of the Service Terminal phone numbers. It is also advisable at this time to program the Panel Identification Number at addresses 84 - 87. This will allow the Service Terminal to easily identify incoming calls.

Exit the Program Mode and return the panel to Normal Mode. Press the **MODE** key followed by the 4-digit code **3696** and then the **[ENTER/STORE]** key.

☛ **3696** spells DOWN on a Touch-Tone® phone.

The display to the far left will flash the letter 'S'. Press the digit '1' for Service Terminal phone #1 or '2' for Service Terminal #2, followed by **[ENTER/STORE]**. The control panel will now call the appropriate Service Terminal phone number and the downloading process will begin.

Once the called Service Terminal identifies the incoming call (control panel), the downloading process is allowed to continue. Downloading progresses until all programmed information has been successfully loaded into the control panel. The programmed data may consist of addresses 00-374 plus the time and date.

7.3 Downloading Initiated at a Service Terminal

Before initiating the download procedure, make certain that the control panel is:

- ✓ *In Normal Mode*
- ✓ *Central Station communications are off or location 56 is set to '0'*
- ✓ *The communicator is in the standby state (red Line Seize LEDs are off, green Modem and Kissoff LEDs are off)*

Once the control panel accepts/answers an incoming call, the panel will:

1. Establish basic modem connection
2. Verify secret code and panel identification number
3. Verify callback vs. no callback request from the service terminal. If callback is requested, steps 4 through 9 will occur. If no callback is requested, only steps 8 and 9 will occur
4. Identify the Service Terminal location
5. Hang-up/disconnect call
6. Call the Central Station(s) and transmit a request for upload/download message (if programmed to do so). If this message is accepted, the control panel will proceed to the next step
7. Return call to Service Terminal
8. After security clearance, begin downloading
9. Upon completion of download, call Central Station(s) back and report either a successful download or failed upload/download message (if programmed to do so)

7.4 Uploading Initiated at a Service Terminal

Items that may be uploaded from the control panel to a Service Terminal are:

- All programmed data from addresses 00-374 plus the real-time clock, time and date
- Entire Walktest data file
- Troubleshoot Mode system voltages
- Entire 32 event History file
- Current system status

Uploading is possible at any time provided the following conditions are true:

- ✓ The control panel must be in the Normal Mode of operation. Uploading is not possible if the panel is in any other mode
- ✓ There cannot be any active communications ongoing with a Central Station receiver
- ✓ All active events must be successfully 'kissed-off' by the Central Station (the communicator must be in a standby state with no new information waiting to be transmitted to a Central Station)

Once an incoming call is accepted/answered by the control panel, the panel will:

1. Establish basic modem connection
2. Verify secret code and panel identification number
3. Verify callback vs. no callback request from the service terminal. If callback is requested, steps 4 through 9 will occur. If no callback is requested, only steps 8 and 9 will occur
4. Identify the Service Terminal location
5. Hang-up/disconnect call
6. Call the Central Station(s) and transmit a request for upload/download message (if programmed to do so). If this message is accepted, the control panel will proceed to the next step
7. Return call to Service Terminal
8. After security clearance, begin uploading
9. Upon completion of upload, call Central Station(s) back and report either a successful upload or failed upload/download message (if programmed to do so).

During the uploading process, the fire protection remains active. Should a system trouble or alarm condition occur, the control panel immediately terminates uploading and processes the trouble or alarm locally and transmits the information to the Central Station(s).

Appendix A *Battery Calculations*

Use the Total Standby and Alarm Load Currents calculated in Table A-2 and Table A-3 for the following battery calculation.

TABLE A-1: Battery Calculations

Standby Load Current (Amps) []	X	Required Standby Time in Hours (24 or 60 Hours) []	=	_____
Alarm Load Current (Amps) []	X	Required Alarm Time in Hours (i.e. 5 minutes = 0.084) []	=	_____
Add Standby and Alarm Load for Required Ampere Hour Battery			=	_____
Multiply by the Derating Factor of 1.2			X 1.2	_____
Total Ampere Hours (AH) Required			=	_____

Note:

1. 7 Ampere Hour battery can be located in the backbox.
2. 12 Ampere Hour and 17 Ampere Hour batteries require the BB-17F battery box.

A.1 The Main Power Supply

The MS-5024UD provides filtered power for operating the fire alarm control panel, external devices and the standby battery. The power for operating external devices is limited. Use Table A-2 (standby or nonalarm) and Table A-3 (alarm) to determine if external loading is within the capabilities of the power supply.

Concerning 4-wire smoke detectors: Be sure to power smoke detectors from TB4, Terminals 3 and 4.

TABLE A-2: Filtered Load in Standby - external devices connected to TB4 only

Device Type	# of Devices		Current (Amps)	=	Total Current (Amps)
Main Circuit Board	1	X	0.1	=	0.1
ADM-24	(1 max.)	X	0.006	=	
RZA-5F	(1 max.)	X	0	=	0
RM-5F	(1 max.)	X	0	=	0
CAC-5F	(1 max.)	X	0	=	0
2-wire Smoke Detector Heads	[]	X	[] ¹	=	
4-wire Smoke Detector Heads	[]	X	[] ¹	=	
Power Supervision ² Relays	[]	X	0.025	=	
Current Draw from TB4 (nonalarm) ³				=	
Sum Column for Standby Load				=	Amps

1. Refer to the Device Compatibility Document for 2-wire smoke detector standby current.
2. Must use compatible listed power supervision relay.
3. The total standby current must include the sum of both the resettable (TB4, Terminals 3 & 4) and nonresettable (TB4, Terminals 5 & 6) power. Caution must be taken to ensure that current drawn from these outputs during alarm does not exceed maximum ratings specified (refer to Table A-3)

TABLE A-3: Filtered Load in Alarm

Device Type	# of Devices		Current (Amps)	=	Total Current (Amps)
Main Circuit Board	1	X	0.170	=	0.170 ¹
ADM-24	(1 max.)	X	0.006	=	
RZA-5F	(1 max.)	X	0.046 ²	=	
RM-5F	(1 max.)	X	0.080 ²	=	
CAC-5F	(1 max.)	X	0	=	0
4-wire Smoke Detector ⁴ Heads	[]	X	[]	=	
Power Supervision Relays ³	[]	X	0.025	=	
Notification Appliances ⁴	[]	X	[]	=	
Notification Appliances ⁴	[]	X	[]	=	
Current Draw from TB4 ⁴ (alarm)				=	
Sum Column for Standby Load⁵				=	Amps

1. The current shown represents one zone on the main circuit board in alarm. For all five zones in alarm, the current draw increases to 0.36 amps.
2. The currents shown for the RZA-5F and RM-5F are for all five zones in alarm. For one zone in alarm, the RZA-5F current draw is 16 mA and the RM-5F current draw is 12 mA.
3. Must use compatible listed Power Supervision Relay.
4. Current limitations of terminals:
 - TB4, Terminals 1 & 2 = 0.300 amp, filtered 24VDC +/- 5%, 120Hz ripple @ 10 mV_{RMS}. Nonresettable power (100Hz ripple for MS-5024UDE).
 - TB4, Terminals 3 & 4 = 0.300 amp, filtered 24VDC +/- 5%, 120Hz ripple @ 10 mV_{RMS}. Resettable power (100Hz ripple for MS-5024UDE)
 - TB5, 2.5 amps.
 - TB6, 2.5 amps.
5. Total Current draw listed above cannot exceed:
 - 3.6 amps with only the standard transformer installed
 - 5.6 amps with both the standard and optional transformer installed

Appendix B *Programming Reference Sheets*

...To enter Programming Mode, press the **MODE** key, the code **7764** and then the **[ENTER/STORE]** key...

₀₀ ₀₁ ₀₂ ₀₃ ₀₄ ₀₅ ₀₆ ₀₇ ₀₈ ₀₉ ₁₀ ₁₁ ₁₂ ₁₃ ₁₄ ₁₅

Addresses 00 to 15 store the Primary Central Station Phone Number. Enter 'F' to represent the end of the number.

₁₆ Primary Central Station Communication Format: Enter '0 - F'.

₁₇ ₁₈ ₁₉ ₂₀ Primary Central Station Account Code: Valid entries are '0 - F'.

₂₁ ₂₂ ₂₃ ₂₄ Primary Central Station 24-Hour Test Time. Enter military time (i.e. 1400 for 2 PM).

₂₅ Primary Number Test Time Interval. Enter '0' for 24 hour; '1' for 12 hour; '2' for 8 hour; '3' for 6 hour.

₂₆ ₂₇ ₂₈ ₂₉ ₃₀ ₃₁ ₃₂ ₃₃ ₃₄ ₃₅ ₃₆ ₃₇ ₃₈ ₃₉ ₄₀ ₄₁

Addresses 26 to 41 store the Secondary Central Station Phone Number. Enter 'F' to represent the end of the number.

₄₂ Secondary Central Station Communication Format: Enter '0 - F'.

₄₃ ₄₄ ₄₅ ₄₆ Secondary Central Station Account Code: Valid entries are '0 - F'.

₄₇ ₄₈ ₄₉ ₅₀ Secondary Central Station 24-Hour Test Time. Enter military time (i.e. 1400 for 2 PM).

₅₁ Secondary Number Test Time Interval. Enter '0' for 24 hour; '1' for 12 hour; '2' for 8 hour; '3' for 6 hour.

₅₂ Alarm Verification. Enter '0' for no verification; '1' for verification of all 2-wire smoke zones.

₅₃ ₅₄ ₅₅ Future use.

₅₆ Slave Communicator/Fire Panel Selection. Enter '0' for fire panel only; '1' for slave communicator only; '2' for fire panel/communicator operation.

₅₇ Zone 1 Function Select. Enter '0' for 2-wire smoke detectors; '1' for pull station; '2' for normally open contact devices; '3' for supervisory devices; '4' for supervisory devices (autoresettable).

₅₈ Zone 2 Function Select. Enter '0' for 2-wire smoke detectors; '1' for pull station; '2' for normally open contact devices; '3' for supervisory devices; '4' for supervisory devices (autoresettable).

₅₉ Zone 3 Function Select. Enter '0' for 2-wire smoke detectors; '1' for pull station; '2' for normally open contact devices; '3' for supervisory devices; '4' for supervisory devices (autoresettable); '5' for waterflow (silenceable); '6' for waterflow (nonsilenceable).

₆₀ Zone 4 Function Select. Enter '0' for 2-wire smoke detectors; '1' for pull station; '2' for normally open contact devices; '3' for supervisory devices; '4' for supervisory devices (autoresettable).

₆₁ Zone 5 Function Select. Enter '0' for 2-wire smoke detectors; '1' for pull station; '2' for normally open contact devices; '3' for supervisory devices; '4' for supervisory devices (autoresettable).

₆₂ ₆₃ Waterflow Retard timer. Enter 0 - 89 additional seconds.

₆₄ AC Loss Delay. Enter '0' for 6 hour delay; '1' for 7 hours; '2' for 8 hours; '3' for 9 hours; '4' for 10 hours; '5' for 11 hours; '6' for 12 hours; '7' for 15 hours; '8' for 16 hours; '9' for 17 hours; 'A' for 18 hours; 'B' for 19 hours; 'C' for 20 hours; 'D' for 21 hours; 'E' for 22 hours; 'F' for 23 hours.

























































































































































































































































₆₅ Alarm Presignal. Enter '0' to disable alarm presignal; '1' to enable.

₆₆ ₆₇ ₆₈ Alarm Presignal Delay Timer. Enter 0 - 179 additional seconds (default - 120 seconds).

₆₉ Notification Appliance Circuit #1 Selection. Enter '0' for enabled (silenceable); '1' for enabled (nonsilenceable); '2' for disabled.

- ₇₀ Silence Inhibit NAC #1. Enter '0' for no silence inhibit; '1' to inhibit silencing of NAC #1 for one minute.
- ₇₁ Autosilence NAC #1. Enter '0' for no autosilence; '1' for 5 minutes; '2' for 10 minutes; '3' for 15 minutes; '4' for 20 minutes; '5' for 25 minutes; '6' for 30 minutes.
- ₇₂ Coding NAC #1. Enter '0' for steady; '1' for March Time (120 ppm); '2' for California (10 seconds On, 5 seconds Off); '3' for Temporal (½ second On, ½ second Off, ½ second On, ½ second Off, ½ second On, 1½ second Off).
- ₇₃ Notification Appliance Circuit #2 Selection. Enter '0' for enabled (silenceable); '1' for enabled (nonsilenceable); '2' for disabled.
- ₇₄ Silence Inhibit NAC #2. Enter '0' for no silence inhibit; '1' to inhibit silencing of NAC #2 for one minute.
- ₇₅ Autosilence NAC #2. Enter '0' for no autosilence; '1' for 5 minutes; '2' for 10 minutes; '3' for 15 minutes; '4' for 20 minutes; '5' for 25 minutes; '6' for 30 minutes.
- ₇₆ Coding NAC #2. Enter '0' for steady; '1' for March Time (120 ppm); '2' for California (10 seconds On, 5 seconds Off); '3' for Temporal (½ second On, ½ second Off, ½ second On, ½ second Off, ½ second On, 1½ second Off)
- ₇₇ Trouble Reminder. Enter '0' to disable trouble reminder; '1' to enable.
- ₇₈ Annunciator/Printer Supervision. Enter '0' for annunciator/printer not present; '1' for annunciator present; '2' for printer present; '3' for annunciator and printer present.
- ₇₉ Backup Reporting. Enter '0' to report to secondary phone number as backup only; '1' to report to secondary phone number for all reports/messages. Does not affect upload/download messages.
- ₈₀ Touchtone/Rotary Select. Enter '0' for touchtone dialing; '1' for rotary dialing.
- ₈₁ Make/Break Ratio. Enter '0' for 67/33 ratio; '1' for 62/38 ratio.
- ₈₂ Future use.
- ₈₃ Future use.
- ₈₄ ₈₅ ₈₆ ₈₇ Panel Identification Number. Valid entries are '0 - F'.
- ₈₈ ₈₉ ₉₀ ₉₁ ₉₂ ₉₃ ₉₄ ₉₅ ₉₆ ₉₇ ₉₈ ₉₉ ₁₀₀ ₁₀₁ ₁₀₂ ₁₀₃
 Service Terminal #1 Phone Number. Addresses 88 - 103 store the phone number of Service Terminal #1. Enter 'F' to represent the end of the number.
- ₁₀₄ ₁₀₅ Ring Count on Primary Phone Line. Enter number of rings prior to panel answering call.
- ₁₀₆ FAX/Answer Machine, Primary Phone Line. Enter '0' for no sharing of phone line; '1' for sharing.
- ₁₀₇ ₁₀₈ ₁₀₉ ₁₁₀ ₁₁₁ ₁₁₂ ₁₁₃ ₁₁₄ ₁₁₅ ₁₁₆ ₁₁₇ ₁₁₈ ₁₁₉ ₁₂₀ ₁₂₁ ₁₂₂
 Service Terminal #2 Phone Number. Addresses 107 - 122 store the phone number of Service Terminal #2. Enter 'F' to represent the end of the number.
- ₁₂₃ ₁₂₄ Ring Count on Secondary Phone Line. Enter number of rings prior to panel answering call.
- ₁₂₅ FAX/Answer Machine, Secondary Phone Line. Enter '0' for no sharing of phone line; '1' for sharing.
- ₁₂₆ Upload/Download Backup Reporting. Enter '0' for Upload/Download reports to go to the Secondary Central Station Phone Number on backup only; '1' for Upload/Download reports to always go to the Secondary Number.

Programming Reference Sheets

 127	 128	 129	 130	 131	 132	 133	 134	 135	 136	 137	 138	 139
 140	 141	 142	 143	 144	 145	 146	 147	 148	 149	 150	 151	 152
 153	 154	 155	 156	 157	 158	 159	 160	 161	 162	 163	 164	 165
 166	 167	 168	 169	 170	 171	 172	 173	 174	 175	 176	 177	 178
 179	 180	 181	 182	 183	 184	 185	 186	 187	 188	 189	 190	 191
 192	 193	 194	 195	 196	 197	 198	 199	 200	 201	 202	 203	 204
 205	 206	 207	 208	 209	 210	 211	 212	 213	 214	 215	 216	 217
 218	 219	 220	 221	 222	 223	 224	 225	 226	 227	 228	 229	 230
 231	 232	 233	 234	 235	 236	 237	 238	 239	 240	 241	 242	 243
 244	 245	 246	 247	 248	 249	 250	 251	 252	 253	 254	 255	 256
 257	 258	 259	 260	 261	 262	 263	 264	 265	 266	 267	 268	 269
 270	 271	 272	 273	 274	 275	 276	 277	 278	 279	 280	 281	 282
 283	 284	 285	 286	 287	 288	 289	 290	 291	 292	 293	 294	 295
 296	 297	 298	 299	 300	 301	 302	 303	 304	 305	 306	 307	 308
 309	 310	 311	 312	 313	 314	 315	 316	 317	 318	 319	 320	 321
 322	 323	 324	 325	 326	 327	 328	 329	 330	 331	 332	 333	 334
 335	 336	 337	 338	 339	 340	 341	 342	 343	 344	 345	 346	 347
 348	 349	 350	 351	 352	 353	 354	 355	 356	 357	 358	 359	 360
 361	 362	 363	 364	 365	 366	 367	 368	 369	 370	 371	 372	 373
 374												

Programming Reference Sheets - Factory Default Settings

...To enter Programming Mode, press the **MODE** key, the code **7764** and then the **[ENTER/STORE]** key...

F₀₀ **F**₀₁ **F**₀₂ **F**₀₃ **F**₀₄ **F**₀₅ **F**₀₆ **F**₀₇ **F**₀₈ **F**₀₉ **F**₁₀ **F**₁₁ **F**₁₂ **F**₁₃ **F**₁₄ **F**₁₅

Addresses 00 to 15 store the Primary Central Station Phone Number. *Enter 'F' to represent the end of the number.*

E₁₆ Primary Central Station Communication Format: *'E' for Ademco Contact ID.*

0₁₇ **0**₁₈ **0**₁₉ **0**₂₀ Primary Central Station Account Code.

2₂₁ **3**₂₂ **4**₂₃ **5**₂₄ Primary Central Station 24-Hour Test Time. *2345 = 11:45 PM.*

0₂₅ Primary Number Test Time Interval. *'0' for 24 hours.*

F₂₆ **F**₂₇ **F**₂₈ **F**₂₉ **F**₃₀ **F**₃₁ **F**₃₂ **F**₃₃ **F**₃₄ **F**₃₅ **F**₃₆ **F**₃₇ **F**₃₈ **F**₃₉ **F**₄₀ **F**₄₁

Addresses 26 to 41 store the Secondary Central Station Phone Number. *Enter 'F' to represent the end of the number.*

E₄₂ Secondary Central Station Communication Format: *'E' for Ademco Contact ID.*

0₄₃ **0**₄₄ **0**₄₅ **0**₄₆ Secondary Central Station Account Code.

0₄₇ **0**₄₈ **0**₄₉ **0**₅₀ Secondary Central Station 24-Hour Test Time. *0000 = 12:00 midnight.*

0₅₁ Secondary Number Test Time Interval. *'0' for 24 hours.*

0₅₂ Alarm Verification. *'0' for no verification.*

0₅₃ **0**₅₄ **0**₅₅ Future use.

0₅₆ Slave Communicator/Fire Panel Selection. *'0' for fire panel only operation.*

0₅₇ Zone 1 Function Select. *'0' for 2-wire smoke detectors.*

0₅₈ Zone 2 Function Select. *'0' for 2-wire smoke detectors.*

0₅₉ Zone 3 Function Select. *'0' for 2-wire smoke detectors.*

0₆₀ Zone 4 Function Select. *'0' for 2-wire smoke detectors.*

0₆₁ Zone 5 Function Select. *'0' for 2-wire smoke detectors.*

0₆₂ **0**₆₃ Waterflow Retard timer. *'00' for no delay.*

0₆₄ AC Loss Delay. *'0' for 6 hour delay.*

0₆₅ Alarm Presignal. *'0' for no alarm presignal.*

1₆₆ **2**₆₇ **0**₆₈ Alarm Presignal Delay Timer. *120 second alarm presignal delay.*

0₆₉ Notification Appliance Circuit #1 Selection. *'0' for enabled (silenceable).*

0₇₀ Silence Inhibit NAC #1. *'0' for no silence inhibit.*

0₇₁ Autosilence NAC #1. *'0' for no autosilence.*

0₇₂ Coding NAC #1. *'0' for steady no coding.*

0₇₃ Notification Appliance Circuit #2 Selection. *'0' for enabled (silenceable).*

0₇₄ Silence Inhibit NAC #2. '0' for no silence inhibit.

0₇₅ Autosilence NAC #2. '0' for no autosilence.

0₇₆ Coding NAC #2. '0' for steady no coding.

0₇₇ Trouble Reminder. '0' for no trouble reminder.

0₇₈ Annunciator/Printer Supervision. '0' for annunciator/printer not present.

0₇₉ Backup Reporting. '0' to report to secondary phone number as backup only.

0₈₀ Touchtone/Rotary Select. '0' for touchtone dialing.

0₈₁ Make/Break Ratio. '0' for 67/33 ratio.

0₈₂ Future use. Leave default of '0'.

0₈₃ Future use. Leave default of '0'.

0₈₄ **0**₈₅ **0**₈₆ **0**₈₇ Panel Identification Number. Default is '0000'.

F₈₈ **F**₈₉ **F**₉₀ **F**₉₁ **F**₉₂ **F**₉₃ **F**₉₄ **F**₉₅ **F**₉₆ **F**₉₇ **F**₉₈ **F**₉₉ **F**₁₀₀ **F**₁₀₁ **F**₁₀₂ **F**₁₀₃

Service Terminal #1 Phone Number. Enter 'F' to represent the end of the number.

0₁₀₄ **3**₁₀₅ Ring Count on Primary Phone Line. Default is '03' for do not answer until 3 rings are detected.

0₁₀₆ FAX/Answer Machine, Primary Phone Line. '0' for no sharing of phone line.

F₁₀₇ **F**₁₀₈ **F**₁₀₉ **F**₁₁₀ **F**₁₁₁ **F**₁₁₂ **F**₁₁₃ **F**₁₁₄ **F**₁₁₅ **F**₁₁₆ **F**₁₁₇ **F**₁₁₈ **F**₁₁₉ **F**₁₂₀ **F**₁₂₁ **F**₁₂₂

Service Terminal #2 Phone Number. Enter 'F' to represent the end of the number.

0₁₂₃ **3**₁₂₄ Ring Count on Secondary Phone Line. Default is '03' for do not answer until 3 rings are detected.

0₁₂₅ FAX/Answer Machine, Secondary Phone Line. '0' for no sharing of phone line.

0₁₂₆ Upload/Download Backup Reporting. '0' for Upload/Download reports to go to the Secondary Central Station Phone Number on backup only.

Programming Reference Sheets Factory Default

1 ₁₂₇	1 ₁₂₈	1 ₁₂₉	1 ₁₃₀	1 ₁₃₁	1 ₁₃₂	1 ₁₃₃	1 ₁₃₄	1 ₁₃₅	1 ₁₃₆	1 ₁₃₇	1 ₁₃₈	1 ₁₃₉
1 ₁₄₀	1 ₁₄₁	5 ₁₄₂	7 ₁₄₃	0 ₁₄₄	5 ₁₄₅	7 ₁₄₆	0 ₁₄₇	5 ₁₄₈	7 ₁₄₉	0 ₁₅₀	5 ₁₅₁	7 ₁₅₂
0 ₁₅₃	5 ₁₅₄	7 ₁₅₅	0 ₁₅₆	6 ₁₅₇	0 ₁₅₈	4 ₁₅₉	3 ₁₆₀	0 ₁₆₁	1 ₁₆₂	3 ₁₆₃	8 ₁₆₄	0 ₁₆₅
3 ₁₆₆	8 ₁₆₇	0 ₁₆₈	3 ₁₆₉	8 ₁₇₀	0 ₁₇₁	3 ₁₇₂	8 ₁₇₃	0 ₁₇₄	3 ₁₇₅	8 ₁₇₆	0 ₁₇₇	3 ₁₇₈
1 ₁₇₉	0 ₁₈₀	3 ₁₈₁	0 ₁₈₂	2 ₁₈₃	3 ₁₈₄	1 ₁₈₅	1 ₁₈₆	3 ₁₈₇	5 ₁₈₈	1 ₁₈₉	3 ₁₉₀	5 ₁₉₁
2 ₁₉₂	3 ₁₉₃	2 ₁₉₄	1 ₁₉₅	3 ₁₉₆	2 ₁₉₇	2 ₁₉₈	3 ₁₉₉	5 ₂₀₀	4 ₂₀₁	3 ₂₀₂	5 ₂₀₃	4 ₂₀₄
3 ₂₀₅	3 ₂₀₆	0 ₂₀₇	3 ₂₀₈	0 ₂₀₉	8 ₂₁₀	6 ₂₁₁	0 ₂₁₂	2 ₂₁₃	6 ₂₁₄	0 ₂₁₅	8 ₂₁₆	4 ₂₁₇
1 ₂₁₈	1 ₂₁₉	4 ₂₂₀	1 ₂₂₁	6 ₂₂₂	4 ₂₂₃	1 ₂₂₄	2 ₂₂₅	4 ₂₂₆	1 ₂₂₇	3 ₂₂₈		

Appendix C *Operation and Function Modes*

C.1 Operation Modes

TABLE C-1: Operation Modes

CODE	ACTIVITY	NOTES
6676 (NORM)	Returns to normal operation	Fire protection is on
7764 (PROG)	Enters Program Mode	4 levels of programming may be entered. Fire protection is off
9255 (WALK)	Enters Walktest Mode	May select audible walktest function. Fire protection is off
4478 (HIST)	View History File	Use display or printer to view History File. Fire protection is off
8768 (TROU)	Activates internal system voltmeter for troubleshooting and diagnosing problems	Fire protection is off while voltmeter function is enabled
7746 (PRIN)	Sends status, history file, walktest file, troubleshoot voltages and entire programming selections to printer	Fire protection is off. Requires PRT-24 option module
5267 (LAMP)	Turns on all LEDs on the main circuit board and all system annunciators for five seconds	Fire protection is on
3696 (DOWN)	Allows for downloading the entire program file to the panel	Must have service terminal ready. Fire protection remains on

C.2 Function Modes

TABLE C-2: Function Modes

CODE	ACTIVITY	NOTES
3472 (DISA)	Allows disabling of any input zone	May only disable one zone at a time. Places system into trouble
3622 (ENAB)	Allows enabling (return to normal) of any zone	May only enable one zone at a time
3745 (DRIL)	Performs drill function by turning on all NAC outputs	Transmission of drill function to Central Station is defaulted to ON
3337 (DEFP)	Reprograms all entries for programming back to the original factory settings	Entry of code must be performed two times in rapid succession as a safety feature. Use caution when using this feature

Appendix D *Ademco Contact ID Format Event Code Descriptions*

This appendix describes the various Event Codes and their messages which are available for the Ademco Contact ID Format.

The reporting structure for the Ademco Contact ID Format is as follows:

SSS 18 QXYZ GG CCC

where

- SSSS = Four digit Subscriber ID Account Code (addresses 17 - 20 and 43 - 46)
- 18 = Identifies transmission as Contact ID to the receiver at the Central Station
- Q = Event Qualifier where 1 = New Event and 3 = New Restore
- XYZ = Event code (shown in Table 3-3 on page 38 and Table 3-6 on page 43)
- GG = Group number
- CCC = Zone number

Notes:

1. GG Group Number is fixed at '00' and cannot be changed.
2. CCC Zone Number is transmitted as '001' for zone one up to '005' for zone five.

Ademco Contact ID Reporting Structure

A typical printout from a Central Station receiver (such as the Ademco 685) of alarm and trouble reports in the Ademco Contact ID Reporting Structure follows:

<u>Time</u>	<u>Date</u>	<u>Rcvr/Line ID</u>	<u>SSSS</u>	<u>QXYZ</u>	<u>GG</u>	<u>CCCC</u>
11:28	03/25	11	7777	E110	00	C001 - general fire alarm on zone one
11:28	03/25	11	7777	E111	00	C002 - smoke detector alarm on zone two
11:28	03/25	11	7777	E380	00	C003 - fault on zone three
11:28	03/25	11	7777	E570	00	C004 - Zone four disabled
11:28	03/25	11	7777	R110	00	C001 - Zone one alarm restored
11:28	03/25	11	7777	R111	00	C002 - smoke detector zone two restored
11:28	03/25	11	7777	R380	00	C003 - zone three fault restored
11:28	03/25	11	7777	R570	00	C004 - zone four reenabled
11:28	03/25	11	7777	E158	00	C005 - high temperature, zone five
11:28	03/25	11	7777	E151	00	C003 - gas detected, zone three

Notes:

1. 18, which is used in the reporting structure to identify the transmission as Contact ID, is not printed out in the alarm and trouble report.
2. Q, which is the Event Qualifier for the reporting structure, is printed out in the report as an E for New Event or R for New Restore.

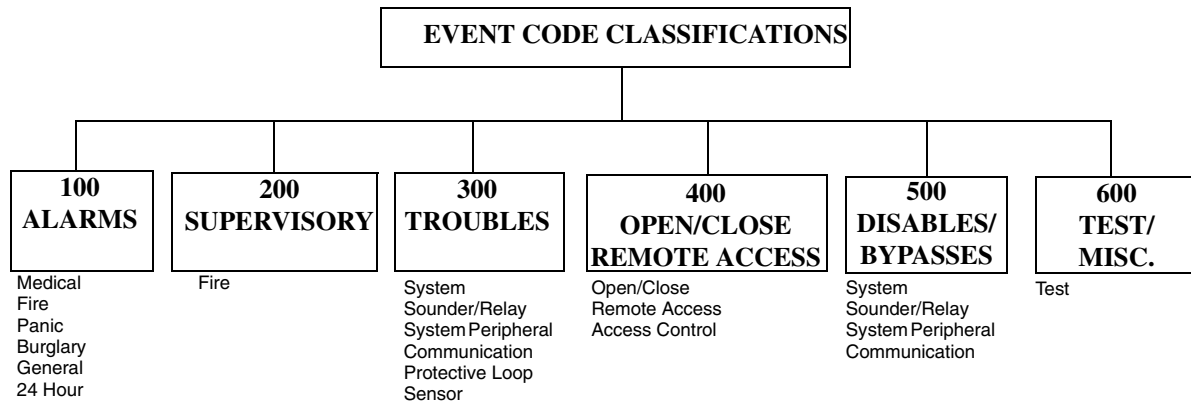

EVENT

Medical Alarms - 100

- 100 Medical
- 101 Pendant transmitter
- 102 Fail to report in

Fire Alarms - 110

- 110 Fire Alarm
- 111 Smoke
- 112 Combustion
- 113 Waterflow
- 114 Heat
- 115 Pull station
- 116 Duct
- 117 Flame
- 118 Near Alarm

Panic Alarms - 120

- 120 Panic Alarm
- 121 Duress
- 122 Silent
- 123 Audible

Burglar Alarms - 130

- 130 Burglary
- 131 Perimeter
- 132 Interior
- 133 24-Hour
- 134 Entry/Exit
- 135 Day/Night
- 136 Outdoor
- 137 Tamper
- 138 Near Alarm

General Alarms - 140

- 140 General Alarm
- 141 Polling loop open
- 142 Polling loop short
- 143 Expansion module failure
- 144 Sensor tamper
- 145 Expansion module tamper

MESSAGE

- EMERG - Personal Emergency - #
- EMERG - Personal Emergency - #
- EMERG - Fail to Check-in - #

- FIRE - Fire Alarm - #
- FIRE - Smoke Detector - #
- FIRE - Combustion - #
- FIRE - Waterflow - #
- FIRE - Heat Sensor - #
- FIRE - Pull Station - #
- FIRE - Duct Sensor - #
- FIRE - Flame Sensor - #
- FIRE - Near Alarm - #

- PANIC - Panic - #
- PANIC - Duress
- PANIC - Silent Panic - #
- PANIC - Audible Panic - #

- BURG - Burglary - #
- BURG - Perimeter - #
- BURG - Interior - #
- BURG - 24-Hour - #
- BURG - Entry/Exit - #
- BURG - Day/Night - #
- BURG - Outdoor - #
- BURG - Tamper - #
- BURG - Near Alarm - #

- ALARM - General Alarm - #
- ALARM - Polling Loop Open - #
- ALARM - Polling Loop Short - #
- ALARM - Exp. Module Fail - #
- ALARM - Sensor Tamper - #
- ALARM - Exp. Module Tamper - #

Ademco Contact ID Format Event Code Descriptions

EVENT

MESSAGE

24 Hour Non-Burglary - 150 and 160

150 24-Hour Non-Burg	ALARM - 24-Hr. Non-Burg - #
151 Gas detected	ALARM - Gas Detected - #
152 Refrigeration	ALARM - Refrigeration - #
153 Loss of heat	ALARM - Heating System - #
154 Water leakage	ALARM - Water Leakage - #
155 Foil break	ALARM - Foil Break - #
156 Day trouble	ALARM - Day Zone - #
157 Low bottled gas level	ALARM - Low Gas Level - #
158 High temp	ALARM - High Temperature - #
159 Low temp	ALARM - Low Temperature - #
161 Loss of air flow	ALARM - Air Flow - #

Fire Supervisory - 200 and 210

200 Fire supervisory	SUPER. - Fire Supervisory - #
201 Low water pressure	SUPER. - Low Water Pressure - #
202 Lox CO2	SUPER. - Low CO2
203 Gate valve sensor	SUPER. - Gate Valve - #
204 Low water level	SUPER. - Low Water Level - #
205 Pump activated	SUPER. - Pump Activation - #
206 Pump failure	SUPER. - Pump Failure - #

System Troubles - 300 and 310

300 System trouble	TROUBLE - System Trouble
301 AC loss	TROUBLE - AC Power
302 Low system battery	TROUBLE - System Low Battery
303 RAM checksum bad	TROUBLE - Bad RAM Checksum (Restore not applicable)
304 ROM checksum bad	TROUBLE - Bad ROM Checksum (Restore not applicable)
305 System reset	TROUBLE - System Reset (Restore not applicable)
306 Panel program changed	TROUBLE - Programming Changed (Restore not applicable)
307 Self-test failure	TROUBLE - Self Test Failure
308 System shutdown	TROUBLE - System Shutdown
309 Battery test failure	TROUBLE - Battery Test Failure
310 Ground fault	TROUBLE - Ground Fault - #
311 No battery	TROUBLE - No Battery

Sounder/Relay Troubles - 320

320 Sounder/Relay	TROUBLE - Sounder Relay - #
321 Bell 1	TROUBLE - Bell/Siren #1
322 Bell 2	TROUBLE - Bell/Siren #2
323 Alarm relay	TROUBLE - Alarm Relay
324 Trouble relay	TROUBLE - Trouble Relay
325 Reversing	TROUBLE - Reversing Relay
326 Bell 3	TROUBLE - Bell/Siren #3
327 Bell 4	TROUBLE - Bell/Siren #4

System Peripheral Troubles - 330 and 340

330 System peripheral	TROUBLE - Sys. Peripheral - #
331 Polling loop open	TROUBLE - Polling Loop Open
332 Polling loop short	TROUBLE - Polling Loop Short
333 Expansion module failure	TROUBLE - Exp. Module Fail - #
334 Repeater failure	TROUBLE - Repeater Failure - #
335 Local printer paper out	TROUBLE - Printer Paper Out
336 Local printer failure	TROUBLE - Local Printer

Ademco Contact ID Format Event Code Descriptions

EVENT	MESSAGE
<u>Communication Troubles - 350 and 360</u>	
350 Communication	TROUBLE - Communication Trouble
351 Telco 1 fault	TROUBLE - Phone Line #1
352 Telco 2 fault	TROUBLE - Phone Line #2
353 Long range radio xmitter fault	TROUBLE - Radio Transmitter
354 Fail to communicate	TROUBLE - Fail to Communicate
355 Loss of radio supervision	TROUBLE - Radio Supervision
356 Loss of central polling	TROUBLE - Central Radio Polling
<u>Protection Loop Troubles - 370</u>	
370 Protection loop	TROUBLE - Protection Loop - #
371 Protection loop open	TROUBLE - Protection Loop Open - #
372 Protection loop short	TROUBLE - Protection Loop Short - #
373 Fire Trouble	TROUBLE - Fire Loop - #
<u>Sensor Troubles - 380</u>	
380 Sensor trouble	TROUBLE - Sensor Trouble - #
381 Loss of supervision - RF	TROUBLE - RF Sensor Supervision - #
382 Loss of supervision - RPM	TROUBLE - RPM Sensor Supervision - #
383 Sensor tamper	TROUBLE - Sensor Tamper - #
384 RF transmitter low battery	TROUBLE - RF Sensor Batt. - #
<u>Open/Close - 400</u>	
400 Open/Close	OPENING CLOSING
401 Open/Close by user	OPENING - User # CLOSING - User #
402 Group Open/Close	OPENING - Group User # CLOSING - Group User #
403 Automatic Open/Close	OPENING - Automatic CLOSING - Automatic
404 Late Open/Close	OPENING - Late CLOSING - Late
405 Deferred Open/Close	Opening not used Closing not used
406 Cancel	OPENING - Cancel Closing not used
407 Remote arm/disarm	OPENING - Remote CLOSING - Remote
408 Quick arm	Opening not applicable CLOSING - Quick arm
409 Keyswitch Open/Close	OPENING - Keyswitch CLOSING - Keyswitch
<u>Remote Access - 410</u>	
411 Callback request made	REMOTE - Callback Requested Restore not applicable
412 Success - download/access	REMOTE - Successful Access Restore not applicable
413 Unsuccessful access	REMOTE - Unsuccessful Access Restore not applicable
414 System shutdown	REMOTE - System Shutdown
415 Dialer shutdown	REMOTE - Dialer Shutdown
416 Success - upload/access	REMOTE - Successful Access Restore not applicable
<u>Access Control - 420</u>	
421 Access denied	ACCESS - Access Denied - User # Restore not used
422 Access report by user	ACCESS - Access Gained - User # Restore not used
<u>System Disables - 500 and 510</u>	

Ademco Contact ID Format Event Code Descriptions

EVENT

MESSAGE

Sounder/Relay Disables - 520

520 Sounder/Relay disable	DISABLE - Sounder/Relay - #
521 Bell 1 disable	DISABLE - Bell/Siren - #1
522 Bell 2 disable	DISABLE - Bell/Siren - #2
523 Alarm relay disable	DISABLE - Alarm Relay
524 Trouble relay disable	DISABLE - Trouble Relay
525 Reversing relay disable	DISABLE - Reversing Relay
526 Bell 3 disable	DISABLE - Bell/Siren - #3
527 Bell 4 disable	DISABLE - Bell/Siren - #4

System Peripheral Disables - 530 and 540

Communication Disables - 550 and 560

551 Dialer disabled	DISABLE - Dialer Disable
552 Radio transmitter disabled	DISABLE - Radio Disable

Bypasses - 570

570 Zone bypass	BYPASS - Zone Bypass - #
571 Fire bypass	BYPASS - Fire Bypass - #
572 24-Hour zone bypass	BYPASS - 24-Hour Bypass - #
573 Burglar bypass	BYPASS - Burg. Bypass - #
574 Group bypass	BYPASS - Group Bypass - #

Test Misc. - 600

601 Manual trigger test	TEST - Manually Triggered	Restore not applicable
602 Periodic test report	TEST - Periodic	Restore not applicable
603 Periodic RF transmission	TEST - Periodic Radio	Restore not applicable
604 Fire test	TEST - Fire Test	Restore not used
605 Status report to follow	STATUS - Status Follows	Restore not applicable
606 Listen-in to follow	LISTEN - Listen-in Active	Restore not applicable
607 Walk test mode	TEST - Walk Test Mode	
608 System abnormal test	TEST - System Abnormal Test	

Notes

Index

Numerics

1st EVENT 13, 51

A

AC Line Voltage 65
AC Loss Reporting Delay 46
AC Power 16
AC Power LED 13, 52
Ademco Contact ID format 83
Ademco Express 14
ADM-24 29
ADM-24 Annunciator Driver
Module 15, 28
Alarm LED 13, 52
Alarm Presignal 46
Alarm Presignal Delay Timer 46
Alarm Response 53
Alarm Restoral 54
Alarm Verification 44
Alarm verification 10
Annunciator/Printer Supervision 47
Autosilence 10
Autosilence Notification Appliance
Circuit #1 46
Autosilence Notification Appliance
Circuit #2 46
Auxiliary Output 17
Auxiliary Power 24

B

Backbox 19
backbox
see also cabinet 14
Backup Reporting 47
battery 15, 16
Charger Capacity 16
Charging Circuit 16
battery box 15, 16, 21
Battery Calculations 73
Battery Charger 13
Battery Voltage 65
BB-17F 16
see also battery box 15

C

cabinet 14
Cabinet Dimensions 20
CAC-5F Class A Converter
Module 10, 15, 32
Callback 70
Central Station 10, 70
Central Station Communications 57
Circuit
Input 13
Output 13
circuit
Input 23
output 24
Coding Notification Appliance Circuit
#1 46
Coding Notification Appliance Circuit
#2 47
Communication Failure 17
communication format 14
Controls 13

D

Default Programming 49

Digital Communicator 14, 18, 27
digital communicator 10
Display 51
see also Indicators 13
Downloading 69, 71
DP-5024UD 14
see also Dress Panel 11
Dress Panel 11, 16

E

Earth Ground 22
End Programming 49
ENTER/STORE 13, 51
Error Checking 70
event code classification 84

F

FAX/Answer Machine, Primary Phone
Line 48
FAX/Answer Machine, Secondary
Phone Line 48
Fire Drill 56
Fire Panel 10
Format Selection Address 58
Formats 38, 43
Form-C 25
see also relay 17
four-wire smoke detector 10
Four-Wire Smoke Detector Power 17
Current 17
Function Modes 82
Function Selection 45

H

History file 10
History Mode 50, 63

I

IDC
current 23
see also Initiating Device Circuit 23
Indicators 13
Initiating Device Circuit 16
Alarm Current 16
End-of-Line Resistor 16
Maximum Loop Resistance 16
Normal Operating Voltage 16
Short Circuit Current 16
Standby Current 16
Installation 19

K

Keypad 34
Kissoff 10
Kissoff LED 13, 52

L

Lamp Test 66
Line Seizure 14

M

Main Circuit Board 9, 14
Make/Break Ratio 47
MODE 13, 51
Modem LED 13, 52
Mounting 19
MS-5024UD 10

N

NAC 24, 66
current/circuit 17
End-of-Line Resistor 17
Maximum Current 17
Operating Voltage 17
see also Notification Appliance
Circuit 10
Nonresettable Filtered 24V Power 17
Current 17
Nonresettable Power 13
Normal Mode 50
Notification Appliance Circuit 10, 12,
14, 17, 24
Notification Appliance Circuit #1
Enable 46
Notification Appliance Circuit #2
Enable 46

O

Off Normal Reporting 55
Operating Instructions 50
Operation 53
Operation Modes 82

P

Panel Identification Number 47, 70
Piezo
see also Sounder 13
PK-5024UD 10, 16
Power 22
Primary Central Station Number 24
Hour Test Time 39
Primary Central Station Number 24/12/
8/6 Hour Test Time
Interval 39
Primary Central Station Number
Account Code 39
Primary Central Station Number
Communication Format 35
Primary Central Station Phone
Number 34
Primary Line Active LED 52
Primary Phone Line 14
Primary Phone Line Active LED 13
primary phone number 33
Primary Power
see also AC Power 22
Primary Telephone Line 13
Print Mode 50, 66
Printer Configuration 30
Printer Port 13
Product Description 10
Product Features 10
Program Mode 33, 50
Programmable Zone ID 10
programmer 33
programmer, built-in 10
Programming 76
Programming Event Codes 48
Programming Instructions 33
Programming Options 34
PRT-24
Installation 30
PRT-24 Printer Interface Modul 16
PRT-24 Printer Interface Module 11,
30
pull station 10, 23

R

Real-Time Clock and Calendar 48
 Real-Time clock and calendar 10
 Receivers 61
 Relay 14
 relay 10, 11, 12, 17, 25
 contact rating 14, 17, 25
 driver 14, 17, 25
 REN
 see also Ringer Equivalence
 Number 18
 RESET 13, 50
 Resettable Power 13, 66
 Ring Count on Primary Phone Line 47
 Ring Count on Secondary Phone
 Line 48
 Ringer Equivalence Number 18
 RM-5F Five-Zone Relay Module 15,
 31
 RM-5F Relay Module 10
 RZA-5F 29
 RZA-5F Remote Annunciator 15, 28

S

Secondary Central Station Number 24
 Hour Test Time 44
 Secondary Central Station Number 24/
 12/8/6 Hour Test Time
 Interval 44
 Secondary Central Station Number
 Account Code 44
 Secondary Central Station Number
 Communication Format 40
 Secondary Central Station Phone
 Number 39
 Secondary Line Active LED 52
 Secondary Phone Line 14
 Secondary Phone Line Active LED 13
 secondary phone number 33
 Secondary Power
 see also battery 22
 Secondary Telephone Line 13
 Secret Code 70
 Security Features 70
 Service Terminal 10
 Service Terminal Number 1 Phone
 Number 47
 Service Terminal Number 2 Phone
 Number 48
 Servicing 62
 SILENCE 13, 51
 Silence inhibit 10
 Silence Inhibit Notification Appliance
 Circuit #1 46
 Silence Inhibit Notification Appliance
 Circuit #2 46
 Silence LED 13, 52
 Slave Communicator 10
 slave communicator 10, 67
 Slave Communicator/Fire Panel
 Selection 44
 Sounder 13
 sounder 15
 Specifications 16
 Style B 10, 13, 23, 32
 Style D 10, 13, 23, 32
 Style Y 10, 14
 Style Z 10, 14
 Supervisory Condition Response 54

Supervisory LED 13, 52
 Supervisory Restoral Response 54
 Switch Functions 34

T

Telephone Circuit 24
 Telephone Circuitry 18
 Telephone Company
 Rights and Warnings 18
 telephone line 27
 Telephone Lines 65
 Time-out 70
 Tone Burst 14
 Touchtone 14
 Touchtone/Rotary Select 47
 transformer 12, 15
 Transmittal Priorities 60
 Trouble Condition Response 55
 Trouble Condition Restoral 55
 Trouble LED 13, 52
 Trouble Reminder 47
 Trouble reminder 10
 Troubleshoot Mode 50, 64
 two-wire smoke detector 10, 23

U

UL Power-limited Wiring
 Requirements 26
 Upload/Download 69
 Upload/Download Reports 48
 Uploading 72

V

Voltages 64
 voltmeter, built-in 10

W

Walktest Mode 50, 62
 waterflow 23
 waterflow device 10
 Waterflow Retard Timer 45

X

XRM-24
 see also transformer 15

Z

Zone Disable/Enable 56
 Zone Voltages 64

Limited Warranty

The manufacturer warrants its products to be free from defects in materials and workmanship for eighteen (18) months from the date of manufacture, under normal use and service. Products are date-stamped at time of manufacture. The sole and exclusive obligation of the manufacturer is to repair or replace, at its option, free of charge for parts and labor, any part which is defective in materials or workmanship under normal use and service. For products not under the manufacturer's date-stamp control, the warranty is eighteen (18) months from date of original purchase by the manufacturer's distributor unless the installation instructions or catalog sets forth a shorter period, in which case the shorter period shall apply. This warranty is void if the product is altered, repaired, or serviced by anyone other than the manufacturer or its authorized distributors, or if there is a failure to maintain the products and systems in which they operate in a proper and workable manner. In case of defect, secure a Return Material Authorization form from our customer service department. Return product, transportation prepaid, to the manufacturer.

This writing constitutes the only warranty made by this manufacturer with respect to its products. The manufacturer does not represent that its products will prevent any loss by fire or otherwise, or that its products will in all cases provide the protection for which they are installed or intended. Buyer acknowledges that the manufacturer is not an insurer and assumes no risk for loss or damages or the cost of any inconvenience, transportation, damage, misuse, abuse, accident, or similar incident.

THE MANUFACTURER GIVES NO WARRANTY, EXPRESSED OR IMPLIED, OF MERCHANTABILITY, FITNESS FOR ANY PARTICULAR PURPOSE, OR OTHERWISE WHICH EXTEND BEYOND THE DESCRIPTION ON THE FACE HEREOF. UNDER NO CIRCUMSTANCES SHALL THE MANUFACTURER BE LIABLE FOR ANY LOSS OF OR DAMAGE TO PROPERTY, DIRECT, INCIDENTAL, OR CONSEQUENTIAL, ARISING OUT OF THE USE OF, OR INABILITY TO USE THE MANUFACTURER'S PRODUCTS. FURTHERMORE, THE MANUFACTURER SHALL NOT BE LIABLE FOR ANY PERSONAL INJURY OR DEATH WHICH MAY ARISE IN THE COURSE OF, OR AS A RESULT OF, PERSONAL, COMMERCIAL, OR INDUSTRIAL USE OF ITS PRODUCTS.

This warranty replaces all previous warranties and is the only warranty made by the manufacturer. No increase or alteration, written or verbal, of the obligation of this warranty is authorized.



World Headquarters

One Fire-Lite Place, Northford, CT 06472-1653 USA

203-484-7161 • Fax 203-484-7118

www.firelite.com

ISO 9001
CERTIFIED
ENGINEERING & MANUFACTURING